

بِسْمِ اللَّهِ الرَّحْمَنِ الرَّحِيمِ

*In the name of God, Allah,
the most Merciful qualitatively,
the most Merciful quantitatively*

Quran and 2012

Secret of the Primes

Ali Adams

2009AD - 1430AH

www.heliwave.com

Prime Factors



Go

Enter a number to factor

8317013902907

Prime

8317013902907

100%

00:00:00 046

Quran 1: The Key (الفاتحة) has
7 verses, 29 words, 139 letters with
digit sums of $7=7$, $2+9=11$, $1+3+9=13$
and a sum of $7+11+13=31$. All are primes!
Guess what 729139 and 139297 are !!!

www.heliwave.com

أَلْحَمْدُ لِلَّهِ رَبِّ الْعَالَمِينَ

Praise is due to the Creator and Sustainer of the worlds

وَالصَّلَاةُ وَالسَّلَامُ عَلَيَّ

may His blessings and peace be upon

الرَّسُولِ الصَّادِقِ الْأَمِينِ

His Prophet, the truthful, the trustworthy

وَعَلَى آلِهِ الطَّاهِرِينَ

and upon his pure progeny,

وَأَصْحَابِهِ الْمُنْتَجِبِينَ

his companions who stood by him along the struggle path,

وَمَنْ سَارَ عَلَيَّ خُطَاهِمَ إِلَى يَوْمِ الدِّينِ

and all who follow their footsteps till Judgment Day.

Contents

<i>Disclaimer</i>	14
<i>Preface</i>	15
<i>Acknowledgments</i>	16
<i>Introduction</i>	17
<i>Prime Numbers</i>	21
<i>Primality of 1</i>	22
<i>Prime Number History</i>	23
<i>Cryptography</i>	26
<i>Research Methodology</i>	27
<i>The Key Chapter</i>	29
<i>The Key Verses</i>	32
<i>40 is for Maturity</i>	34
<i>Extraterrestrial Life</i>	35
<i>Seal of the Quran</i>	36
<i>The Message</i>	38
<i>Chapter Sequence Numbers</i>	40
<i>New Atomic Model</i>	42
<i>Atomic Number, Mass and Weight</i>	43
<i>Abundance of Elements in the Quran</i>	44
<i>Numerology Systems</i>	46
<i>Abjad Numerology System</i>	46
<i>Alphabet Primalogy System</i>	48
<i>PV of The Key Chapter</i>	50
<i>PV of Oneness of God Chapter</i>	52
<i>PV of the Word Allah</i>	54
<i>Other Primalogy Systems</i>	55
<i>The Merciful Verse</i>	57
<i>PV of the Merciful Verse</i>	62
<i>Merciful Verse Numbers</i>	62
<i>Quran and 2012</i>	64
<i>Event Dates</i>	65
<i>Event Locations</i>	69
<i>Quran and 2192</i>	74
<i>Prime Number Density</i>	75
<i>Further Research</i>	77

<i>Search Methods</i>	77
<i>Numbers in Nature</i>	78
<i>Squared Numbers</i>	79
<i>Pythagorean Triples</i>	80
<i>God's Equation</i>	86
<i>The Golden Ratio</i>	87
<i>Fibonacci Numbers</i>	88
<i>Perfect Numbers</i>	89
<i>Circle within Circle</i>	91
<i>Letter Frequency</i>	92
<i>Pictures and Animations</i>	97
<i>Conclusions</i>	98
<i>Further Thoughts</i>	100
<i>Bigger than Infinity</i>	101
<i>Five Domains</i>	102
<i>Body, Soul, and Spirit</i>	104
<i>Dreams and Visions</i>	108
<i>Death versus Returning to God</i>	109
<i>Nearness to God</i>	111
<i>Freewill versus Predestination</i>	113
<i>Year Types in Arabic</i>	115
<i>Hijri Date Line</i>	117
<i>Nuclear Fusion in the Quran</i>	121
<i>Helical Particle Waves</i>	124
<i>Dual Nature of Light</i>	125
<i>Gravitons and Inertial Mass</i>	126
<i>Electric Charges and Magnetic Moments</i>	127
<i>Positive-Negative Neutrons</i>	127
<i>Double Helix Electromagnetic Fields</i>	127
<i>Nature's Binding Forces</i>	128
<i>Supplication of Imam Mehdi</i>	129
<i>Primes Game</i>	131
<i>24hr Clock</i>	134
<i>References</i>	135
<i>About the Author</i>	136
<i>Poems by Author</i>	137

Arabic Summary

القرآن والأعداد الأولية

الحمد لله الذي رزقني الإسلام ديناً ومحمداً نبياً والقرآن كتاباً حياً وعلياً وأبنائه الطاهرين أئمةً يمسوه ويأولوه لنا صلوات الله وسلامه على محمد وآله وأصحابه المنتجبين.

الحمد لله سبحانه وتعالى الذي هَدَانِي إِلَى مِفْتَاحٍ مِنْ مِفْتَاحِ قُرْآنِهِ مُمْتَلِئٍ فِي سُورَةِ الْفَاتِحَةِ الَّتِي تَتَكُونُ مِنْ 7 آيَاتٍ وَ 29 كَلِمَةً وَ 139 حَرْفًا حَيْثُ إِنَّ كُلَّ هَذِهِ الْأَعْدَادِ هِيَ أَعْدَادٌ أَوْلِيَّةٌ.

أعوذ بالله من الشيطان الرجيم بِسْمِ اللَّهِ الرَّحْمَنِ الرَّحِيمِ

1. بِسْمِ اللَّهِ الرَّحْمَنِ الرَّحِيمِ
2. الْحَمْدُ لِلَّهِ رَبِّ الْعَالَمِينَ
3. الرَّحْمَنِ الرَّحِيمِ
4. مَلِكِ يَوْمِ الدِّينِ
5. إِيَّاكَ نَعْبُدُ وَإِيَّاكَ نَسْتَعِينُ
6. أَهْدِنَا الصِّرَاطَ الْمُسْتَقِيمَ
7. صِرَاطَ الَّذِينَ أَنْعَمْتَ عَلَيْهِمْ غَيْرِ الْمَغْضُوبِ عَلَيْهِمْ وَلَا الضَّالِّينَ

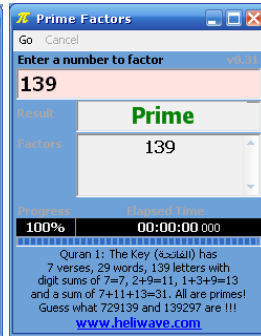
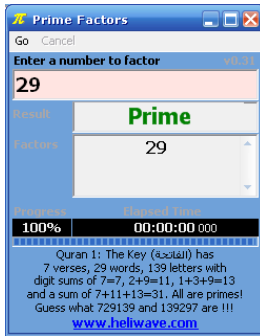
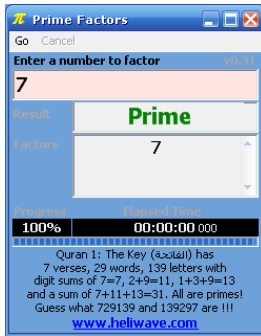

إنّ الأعداد الأوليّة (2 3 5 7 11 13 17 19 23 29 31 37 ... ∞) ليست كالأعداد الفردية التي فقط لا تُقسم على 2 بل هذه أعداد لا تُقسم على أيّ عدد آخر أبداً. لاحظوا إنّ العدد 2 هو عدد أولي والعدد 9 عدد غير أولي لأنه يُقسم على 3.

فُسبحان الله الذي سمّى **سورة الفاتحة** هكذا لا لأنها بداية للقرآن كما هو شأنه بل لكونها **مفتاح القرآن** المُبنى برصانةٍ على الأعداد الأوليّة ذو مجاميع مراتب أوليّة أيضاً (7=7, 11=2+9, 13=1+3+9) وحتى مجموع هذه المجاميع (7+11+13=31) هو أيضاً عدد أولي.

والأكثر دهشة أنّ ترتيب أعداد آيات وكلمات وحروف **سورة الفاتحة** من اليمين الى الشمال (729139) ومن الشمال الى اليمين (139297) هما أيضاً عدّان أوليان بمجاميع مراتب أوليّة أيضاً (31=7+2+9+1+3+9) و (31=1+3+9+2+9+7).

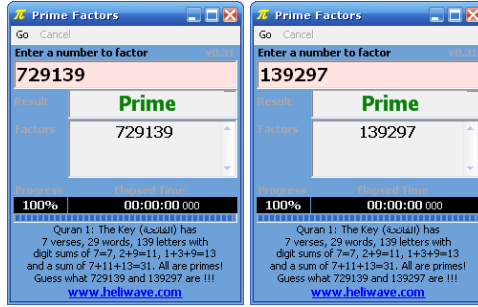

وكلّ هذا هو مجرد إستعداد لما يلي
حيث جعل الله سبحانه وتعالى في **سورة الرحمن 31** إعادة للآية:

فَبَأَىٰ آءَالَاءِ رَبِّكُمَا تُكَذِّبَانِ

سُورَةُ الرَّحْمَنِ

أَعُوذُ بِاللَّهِ مِنَ الشَّيْطَانِ الرَّجِيمِ بِسْمِ اللَّهِ الرَّحْمَنِ الرَّحِيمِ

1. بِسْمِ اللَّهِ الرَّحْمَنِ الرَّحِيمِ
2. أَلَمْ نَعْلَمْ الْقُرْآنَ
3. خَلَقَ الْإِنْسَانَ
4. عَلَّمَهُ الْبَيَانَ
5. أَلَسْمَسُوا الْقَمَرَ بِحُسْبَانٍ
6. وَالنَّجْمِ وَالشَّجَرِ يَسْجُدَانِ
7. وَالسَّمَاءَ رَفَعَهَا وَوَضَعَ الْمِيزَانَ
8. أَلَا تَطْغَوْنَ فِي الْمِيزَانِ
9. وَأَقِيمُوا الْوَزْنَ بِالْقِسْطِ وَلَا تُخْسِرُوا الْمِيزَانَ
10. وَالْأَرْضَ وَضَعَهَا لِلنَّامِ
11. فِيهَا فَكْهَةٌ وَالنَّخْلُ ذَاتُ الْأَكْمَامِ
12. وَالْحَبُّ ذُو الْعَصْفِ وَالرَّيْحَانُ
13. فَبِأَيِّ آيَاتِ اللَّهِ يُكْفَرُونَ
14. خَلَقَ الْإِنْسَانَ مِنْ صَلْصَالٍ كَالْفَخَّارِ
15. وَخَلَقَ الْجَانَّ مِنْ مَّارِجٍ مِنْ نَارٍ
16. فَبِأَيِّ آيَاتِ اللَّهِ يُكْفَرُونَ
17. رَبِّ الْمَشْرِقَيْنِ وَرَبِّ الْمَغْرِبَيْنِ
18. فَبِأَيِّ آيَاتِ اللَّهِ يُكْفَرُونَ
19. مَرَجَ الْبَحْرَيْنِ يَلْتَقِيَانِ
20. بَيْنَهُمَا بَرْزَخٌ لَا يَبْغِيَانِ
21. فَبِأَيِّ آيَاتِ اللَّهِ يُكْفَرُونَ
22. يَخْرُجُ مِنْهُمَا اللَّوْلُؤُ وَالْمَرْجَانُ
23. فَبِأَيِّ آيَاتِ اللَّهِ يُكْفَرُونَ
24. وَلَهُ الْجَوَارِ الْمُنشَآتُ فِي الْبَحْرِ كَالْأَعْلَامِ
25. فَبِأَيِّ آيَاتِ اللَّهِ يُكْفَرُونَ
26. كُلٌّ مِنْ عِنْدِهَا فَنٍ
27. وَيَبْقَى وَجْهَ رَبِّكَ ذُو الْجَلَالِ وَالْإِكْرَامِ
28. فَبِأَيِّ آيَاتِ اللَّهِ يُكْفَرُونَ
29. يَسْأَلُهُ مَنْ فِي السَّمَوَاتِ وَالْأَرْضِ ۚ كُلُّ يَوْمٍ هُوَ فِي شَأْنٍ
30. فَبِأَيِّ آيَاتِ اللَّهِ يُكْفَرُونَ
31. سَنَفَعُ لَكُمْ أَيُّهُ النَّقْلَانِ
32. فَبِأَيِّ آيَاتِ اللَّهِ يُكْفَرُونَ
33. يَمْشُرُ الْجَنِّ وَالْإِنْسَانِ ۚ إِنْ اسْتَطَعْتُمْ أَنْ تَنْفُذُوا مِنْ أَقْطَارِ السَّمَوَاتِ وَالْأَرْضِ فَآتِفُواهُنَّ ۗ لَنْ تَنْفُذُوا ۚ إِنَّا بِسُلْطَنٍ
34. فَبِأَيِّ آيَاتِ اللَّهِ يُكْفَرُونَ
35. يُرْسَلُ عَلَيْكُمَا شَوَاظِمٌ مِنْ نَارٍ وَنَحَاسٌ فَلَا تَنْتَصِرَانِ
36. فَبِأَيِّ آيَاتِ اللَّهِ يُكْفَرُونَ
37. فِإِذَا أَنْشَقَّتْ السَّمَاءُ فَكَانَتْ وَرْدَةً كَالدِّهَانِ

38. فَبِأَيِّ آلَاءِ رَبِّكُمَا تُكَذِّبَانِ
 39. فَيَوْمَئِذٍ لَّا يُسْأَلُ عَنْ ذَنْبِهِ إِنْسٌ وَلَا جَانٌّ
 40. فَبِأَيِّ آلَاءِ رَبِّكُمَا تُكَذِّبَانِ
 41. يُعْرِفُ الْمَجْرُمُونَ بِسِيمَاهُمْ فَيُؤْخَذُ بِالْأَنُوصَى وَالْأَقْدَامِ
 42. فَبِأَيِّ آلَاءِ رَبِّكُمَا تُكَذِّبَانِ
 43. هَذِهِ جَهَنَّمُ الَّتِي يُكَذِّبُ بِهَا الْمَجْرُمُونَ
 44. يَطُوفُونَ بَيْنَهَا وَبَيْنَ حَمِيمٍ ءَانُ
 45. فَبِأَيِّ آلَاءِ رَبِّكُمَا تُكَذِّبَانِ
 46. وَلِمَنْ خَافَ مَقَامَ رَبِّهِ جَنَّاتٌ
 47. فَبِأَيِّ آلَاءِ رَبِّكُمَا تُكَذِّبَانِ
 48. نُوَاتِنَا أَفْنَانُ
 49. فَبِأَيِّ آلَاءِ رَبِّكُمَا تُكَذِّبَانِ
 50. فِيهِمَا عَيْنَانِ تَجْرِيَانِ
 51. فَبِأَيِّ آلَاءِ رَبِّكُمَا تُكَذِّبَانِ
 52. فِيهِمَا مِنْ كُلِّ فَاكِهَةٍ زَوْجَانِ
 53. فَبِأَيِّ آلَاءِ رَبِّكُمَا تُكَذِّبَانِ
 54. مُتَكِينِينَ عَلَى فُرْشٍ بَطَانُهَا مِنْ إِسْتَبْرَقٍ وَجَنَى الْجَنَّتَيْنِ دَانُ
 55. فَبِأَيِّ آلَاءِ رَبِّكُمَا تُكَذِّبَانِ
 56. فِيهِنَّ قَصِيرَاتُ الْإِطْرَفِ لَمْ يَطْمِئِنَّهُنَّ أَنَسٌ قَبْلَهُمْ وَلَا جَانٌّ
 57. فَبِأَيِّ آلَاءِ رَبِّكُمَا تُكَذِّبَانِ
 58. كَأَنَّهُنَّ الْيَاقُوتُ وَالْمَرْجَانُ
 59. فَبِأَيِّ آلَاءِ رَبِّكُمَا تُكَذِّبَانِ
 60. هَلْ جَزَاءُ الْإِحْسَانِ إِلَّا الْإِحْسَانُ
 61. فَبِأَيِّ آلَاءِ رَبِّكُمَا تُكَذِّبَانِ
 62. وَمِنْ دُونِهِمَا جَنَّاتٌ
 63. فَبِأَيِّ آلَاءِ رَبِّكُمَا تُكَذِّبَانِ
 64. مُدْهَامَاتَانِ
 65. فَبِأَيِّ آلَاءِ رَبِّكُمَا تُكَذِّبَانِ
 66. فِيهِمَا عَيْنَانِ تَصَاحَتَانِ
 67. فَبِأَيِّ آلَاءِ رَبِّكُمَا تُكَذِّبَانِ
 68. فِيهِمَا فَاكِهَةٌ وَنَخْلٌ وَرُمَّانٌ
 69. فَبِأَيِّ آلَاءِ رَبِّكُمَا تُكَذِّبَانِ
 70. فِيهِنَّ خَيْرَاتٌ حِسَانٌ
 71. فَبِأَيِّ آلَاءِ رَبِّكُمَا تُكَذِّبَانِ
 72. حُورٌ مَّقْصُورَاتٌ فِي الْخِيَامِ
 73. فَبِأَيِّ آلَاءِ رَبِّكُمَا تُكَذِّبَانِ
 74. لَمْ يَطْمِئِنَّهُنَّ أَنَسٌ قَبْلَهُمْ وَلَا جَانٌّ
 75. فَبِأَيِّ آلَاءِ رَبِّكُمَا تُكَذِّبَانِ
 76. مُتَكِينِينَ عَلَى رُفْرَفٍ خُضْرٍ وَعَبْقَرُى حِسَانِ
 77. فَبِأَيِّ آلَاءِ رَبِّكُمَا تُكَذِّبَانِ
 78. تَبَارَكَ اسْمُ رَبِّكَ ذِي الْجَلَالِ وَالْإِكْرَامِ

و سُبْحَانَهُ جَعَلَ مَجْمُوعَ أَرْقَامِ هَذِهِ الْآيَاتِ:

$$\begin{aligned}
 &+ 36 + 34 + 32 + 30 + 28 + 25 + 23 + 21 + 18 + 16 + 13 \\
 &+ 59 + 57 + 55 + 53 + 51 + 49 + 47 + 45 + 42 + 40 + 38 \\
 &1433 = 77 + 75 + 73 + 71 + 69 + 67 + 65 + 63 + 61 \\
 &\text{عدداً أولياً ومجموع مراتبه (11=1+4+3+3) عدداً أولياً هو الآخر.}
 \end{aligned}$$

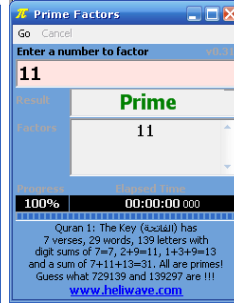
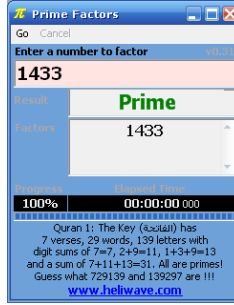
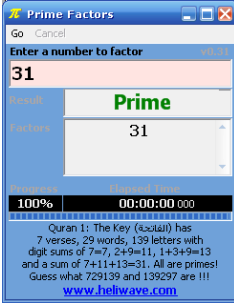

وعندما نعلم إنَّ السَّنةَ الهجريةَ الحاليةَ هي **1430** فلذا قد يُمكننا الظنَّ بأنَّ العَدَدَ الأوَّلِيَّ **1433** قد يُمثِّلُ السَّنةَ الهجريةَ **1433** واللهُ سُبْحَانَهُ وتعالى لم يتركنا للظنون بل أعطانا الدليل الكافي بجعل **سُورَةِ الرَّحْمَنِ** مكونة من **355** كلمةً ببسملتها تماماً كعدد أيام السنة الهجرية.

$$\text{يوماً } 355 = 29+30+29+30+29+30+30+29+30+30+29+30$$

[http://www.islamicfinder.org/Hcal/hdate_year.php?year=1433&base=h]

وبهذا فإنَّ كلَّ كلمةٍ في **سُورَةِ الرَّحْمَنِ** تقابلُ يوماً في السنة الهجرية **1433** وبهذا فإنَّ أوَّلَ تكرارٍ للآيةِ "فَبِأَيِّ آلَاءِ رَبِّكُمَا تُكَذِّبَانِ" يبدأ في الكلمة **44** من السُّورَةِ المقابلِ ليومِ **14 صفر 1433** أو **7 يناير 2012** وآخر تكرارٍ للآيةِ ينتهي في الكلمة **349** المقابلِ ليومِ **23 ذو الحجة 1433** أو **7 نوفمبر 2012**.

وبما أنّ الآية الكريمة مكوّنة من 4 كلمات (**فَبِأَيِّ آلاءِ رَبِّكُمَا تُكَذِّبَانِ**) فإنها تقابلُ 4 أيام ولهذا فإنّه من المحتمل أنّ حدثاً ما بطول 4 أيام **سَيُعَاد** 31 مرة في 2012 والله أعلم. ولربّما سورة **الدُّخَانِ** تُشيرُ لما **سَيُعَاد** 31 مرة قبل **البَطْشَةِ الْكُبْرَى**:

أعوذ بالله من الشيطان الرجيم بِسْمِ اللَّهِ الرَّحْمَنِ الرَّحِيمِ

10. فَأَرْتَقِبْ يَوْمَ تَأْتِي السَّمَاءُ بِدُخَانٍ مُّبِينٍ
11. يَغشى النَّاسَ هَذَا عَذَابٌ أَلِيمٌ
12. رَبِّئِنَّا أَكْشِفُ عَنَّا الْعَذَابَ إِنَّا مُؤْمِنُونَ
13. أَنَّى لَهُمُ الدُّكْرَى وَقَدْ جَاءَهُمْ رَسُولٌ مُّبِينٌ
14. ثُمَّ تَوَلَّوْا عَنْهُ وَقَالُوا مُعَلِّمٌ مَّجْنُونٌ
15. إِنَّا كَاشِفُو الْعَذَابِ قَلِيلًا إِنَّكُمْ عَائِدُونَ
16. يَوْمَ نَبْطِشُ **البَطْشَةَ الْكُبْرَى** إِنَّا مُنتَقِمُونَ

وبما أنّ الأرضَ تدور 4 دورات حول نفسها في 4 أيام لذا فإنّ أيّ حدثاً ما إن كان اتّ من خارج الأرض كحجارةٍ من سَجِيلٍ مثلاً سيضرب الأرض على مدار خط عرض معين ولربما تكون أرقام الآية المعادة هي بعينها خطوط العرض التي يريد الله **الرحمن** سبحانه وتعالى أن يحذّرنا منها وهي:

45° 42° 40° 38° 36° 34° 32° 30° 28° 25° 23° 21° 18° 16° 13°
77° 75° 73° 71° 69° 67° 65° 63° 61° 59° 57° 55° 53° 51° 49° 47°

فإن حدثَ حدثٌ ما على مدار خط عرض 13° شمال أو جنوب أو كليهما في أن واحد (لأنّ الله يخاطب بصيغة المثني في الآية المعادة) فالكل يجب عليه إخلاء خطوط العرض الأخرى بلا تردد والله أعلم حيث يقول في سورة النحل آية 77:

أعوذ بالله من الشيطان الرجيم بِسْمِ اللَّهِ الرَّحْمَنِ الرَّحِيمِ

وَاللَّهُ غَيْبُ السَّمَوَاتِ وَالْأَرْضِ وَمَا أَمْرُ السَّاعَةِ إِنَّا كَلِمَةٌ نَبْرِزُهَا
أَقْرَبُ إِنَّ اللَّهَ عَلَى كُلِّ شَيْءٍ قَدِيرٌ

وَالْحَمْدُ لِلَّهِ رَبِّ الْعَالَمِينَ عَلَى كُلِّ شَيْءٍ

<p style="text-align: center;">MuHarram 1433 Nov - Dec 2011</p> <table border="1"> <thead> <tr><th>S</th><th>S</th><th>M</th><th>T</th><th>W</th><th>T</th><th>F</th></tr> </thead> <tbody> <tr><td>1</td><td>2</td><td>3</td><td>4</td><td>5</td><td>6</td><td>7</td></tr> <tr><td>26</td><td>27</td><td>28</td><td>29</td><td>30</td><td>1</td><td>2</td></tr> <tr><td>8</td><td>9</td><td>10</td><td>11</td><td>12</td><td>13</td><td>14</td></tr> <tr><td>3</td><td>4</td><td>5</td><td>6</td><td>7</td><td>8</td><td>9</td></tr> <tr><td>15</td><td>16</td><td>17</td><td>18</td><td>19</td><td>20</td><td>21</td></tr> <tr><td>10</td><td>11</td><td>12</td><td>13</td><td>14</td><td>15</td><td>16</td></tr> <tr><td>22</td><td>23</td><td>24</td><td>25</td><td>26</td><td>27</td><td>28</td></tr> <tr><td>17</td><td>18</td><td>19</td><td>20</td><td>21</td><td>22</td><td>23</td></tr> <tr><td>29</td><td>30</td><td></td><td></td><td></td><td></td><td></td></tr> <tr><td>24</td><td>25</td><td></td><td></td><td></td><td></td><td></td></tr> </tbody> </table>	S	S	M	T	W	T	F	1	2	3	4	5	6	7	26	27	28	29	30	1	2	8	9	10	11	12	13	14	3	4	5	6	7	8	9	15	16	17	18	19	20	21	10	11	12	13	14	15	16	22	23	24	25	26	27	28	17	18	19	20	21	22	23	29	30						24	25						<p style="text-align: center;">Safar 1433 Dec 2011 - Jan 2012</p> <table border="1"> <thead> <tr><th>S</th><th>S</th><th>M</th><th>T</th><th>W</th><th>T</th><th>F</th></tr> </thead> <tbody> <tr><td></td><td></td><td>1</td><td>2</td><td>3</td><td>4</td><td>5</td></tr> <tr><td></td><td></td><td>26</td><td>27</td><td>28</td><td>29</td><td>30</td></tr> <tr><td>6</td><td>7</td><td>8</td><td>9</td><td>10</td><td>11</td><td>12</td></tr> <tr><td>31</td><td>1</td><td>2</td><td>3</td><td>4</td><td>5</td><td>6</td></tr> <tr><td>13</td><td>14</td><td>15</td><td>16</td><td>17</td><td>18</td><td>19</td></tr> <tr><td>7</td><td>8</td><td>9</td><td>10</td><td>11</td><td>12</td><td>13</td></tr> <tr><td>20</td><td>21</td><td>22</td><td>23</td><td>24</td><td>25</td><td>26</td></tr> <tr><td>14</td><td>15</td><td>16</td><td>17</td><td>18</td><td>19</td><td>20</td></tr> <tr><td>27</td><td>28</td><td>29</td><td></td><td></td><td></td><td></td></tr> <tr><td>21</td><td>22</td><td>23</td><td></td><td></td><td></td><td></td></tr> </tbody> </table>	S	S	M	T	W	T	F			1	2	3	4	5			26	27	28	29	30	6	7	8	9	10	11	12	31	1	2	3	4	5	6	13	14	15	16	17	18	19	7	8	9	10	11	12	13	20	21	22	23	24	25	26	14	15	16	17	18	19	20	27	28	29					21	22	23					<p style="text-align: center;">Rabec' I 1433 Jan - Feb 2012</p> <table border="1"> <thead> <tr><th>S</th><th>S</th><th>M</th><th>T</th><th>W</th><th>T</th><th>F</th></tr> </thead> <tbody> <tr><td></td><td></td><td></td><td>1</td><td>2</td><td>3</td><td>4</td></tr> <tr><td></td><td></td><td></td><td>24</td><td>25</td><td>26</td><td>27</td></tr> <tr><td>5</td><td>6</td><td>7</td><td>8</td><td>9</td><td>10</td><td>11</td></tr> <tr><td>28</td><td>29</td><td>30</td><td>31</td><td>1</td><td>2</td><td>3</td></tr> <tr><td>12</td><td>13</td><td>14</td><td>15</td><td>16</td><td>17</td><td>18</td></tr> <tr><td>4</td><td>5</td><td>6</td><td>7</td><td>8</td><td>9</td><td>10</td></tr> <tr><td>19</td><td>20</td><td>21</td><td>22</td><td>23</td><td>24</td><td>25</td></tr> <tr><td>11</td><td>12</td><td>13</td><td>14</td><td>15</td><td>16</td><td>17</td></tr> <tr><td>26</td><td>27</td><td>28</td><td>29</td><td>30</td><td></td><td></td></tr> <tr><td>18</td><td>19</td><td>20</td><td>21</td><td>22</td><td></td><td></td></tr> </tbody> </table>	S	S	M	T	W	T	F				1	2	3	4				24	25	26	27	5	6	7	8	9	10	11	28	29	30	31	1	2	3	12	13	14	15	16	17	18	4	5	6	7	8	9	10	19	20	21	22	23	24	25	11	12	13	14	15	16	17	26	27	28	29	30			18	19	20	21	22																
S	S	M	T	W	T	F																																																																																																																																																																																																																																																	
1	2	3	4	5	6	7																																																																																																																																																																																																																																																	
26	27	28	29	30	1	2																																																																																																																																																																																																																																																	
8	9	10	11	12	13	14																																																																																																																																																																																																																																																	
3	4	5	6	7	8	9																																																																																																																																																																																																																																																	
15	16	17	18	19	20	21																																																																																																																																																																																																																																																	
10	11	12	13	14	15	16																																																																																																																																																																																																																																																	
22	23	24	25	26	27	28																																																																																																																																																																																																																																																	
17	18	19	20	21	22	23																																																																																																																																																																																																																																																	
29	30																																																																																																																																																																																																																																																						
24	25																																																																																																																																																																																																																																																						
S	S	M	T	W	T	F																																																																																																																																																																																																																																																	
		1	2	3	4	5																																																																																																																																																																																																																																																	
		26	27	28	29	30																																																																																																																																																																																																																																																	
6	7	8	9	10	11	12																																																																																																																																																																																																																																																	
31	1	2	3	4	5	6																																																																																																																																																																																																																																																	
13	14	15	16	17	18	19																																																																																																																																																																																																																																																	
7	8	9	10	11	12	13																																																																																																																																																																																																																																																	
20	21	22	23	24	25	26																																																																																																																																																																																																																																																	
14	15	16	17	18	19	20																																																																																																																																																																																																																																																	
27	28	29																																																																																																																																																																																																																																																					
21	22	23																																																																																																																																																																																																																																																					
S	S	M	T	W	T	F																																																																																																																																																																																																																																																	
			1	2	3	4																																																																																																																																																																																																																																																	
			24	25	26	27																																																																																																																																																																																																																																																	
5	6	7	8	9	10	11																																																																																																																																																																																																																																																	
28	29	30	31	1	2	3																																																																																																																																																																																																																																																	
12	13	14	15	16	17	18																																																																																																																																																																																																																																																	
4	5	6	7	8	9	10																																																																																																																																																																																																																																																	
19	20	21	22	23	24	25																																																																																																																																																																																																																																																	
11	12	13	14	15	16	17																																																																																																																																																																																																																																																	
26	27	28	29	30																																																																																																																																																																																																																																																			
18	19	20	21	22																																																																																																																																																																																																																																																			
<p style="text-align: center;">Rabec' II 1433 Feb - Mar 2012</p> <table border="1"> <thead> <tr><th>S</th><th>S</th><th>M</th><th>T</th><th>W</th><th>T</th><th>F</th></tr> </thead> <tbody> <tr><td></td><td></td><td></td><td></td><td></td><td>1</td><td>2</td></tr> <tr><td></td><td></td><td></td><td></td><td></td><td>23</td><td>24</td></tr> <tr><td>3</td><td>4</td><td>5</td><td>6</td><td>7</td><td>8</td><td>9</td></tr> <tr><td>25</td><td>26</td><td>27</td><td>28</td><td>29</td><td>1</td><td>2</td></tr> <tr><td>10</td><td>11</td><td>12</td><td>13</td><td>14</td><td>15</td><td>16</td></tr> <tr><td>3</td><td>4</td><td>5</td><td>6</td><td>7</td><td>8</td><td>9</td></tr> <tr><td>17</td><td>18</td><td>19</td><td>20</td><td>21</td><td>22</td><td>23</td></tr> <tr><td>10</td><td>11</td><td>12</td><td>13</td><td>14</td><td>15</td><td>16</td></tr> <tr><td>24</td><td>25</td><td>26</td><td>27</td><td>28</td><td>29</td><td>30</td></tr> <tr><td>17</td><td>18</td><td>19</td><td>20</td><td>21</td><td>22</td><td>23</td></tr> </tbody> </table>	S	S	M	T	W	T	F						1	2						23	24	3	4	5	6	7	8	9	25	26	27	28	29	1	2	10	11	12	13	14	15	16	3	4	5	6	7	8	9	17	18	19	20	21	22	23	10	11	12	13	14	15	16	24	25	26	27	28	29	30	17	18	19	20	21	22	23	<p style="text-align: center;">Jumaadi I 1433 Mar - Apr 2012</p> <table border="1"> <thead> <tr><th>S</th><th>S</th><th>M</th><th>T</th><th>W</th><th>T</th><th>F</th></tr> </thead> <tbody> <tr><td>1</td><td>2</td><td>3</td><td>4</td><td>5</td><td>6</td><td>7</td></tr> <tr><td>24</td><td>25</td><td>26</td><td>27</td><td>28</td><td>29</td><td>30</td></tr> <tr><td>8</td><td>9</td><td>10</td><td>11</td><td>12</td><td>13</td><td>14</td></tr> <tr><td>31</td><td>1</td><td>2</td><td>3</td><td>4</td><td>5</td><td>6</td></tr> <tr><td>15</td><td>16</td><td>17</td><td>18</td><td>19</td><td>20</td><td>21</td></tr> <tr><td>7</td><td>8</td><td>9</td><td>10</td><td>11</td><td>12</td><td>13</td></tr> <tr><td>22</td><td>23</td><td>24</td><td>25</td><td>26</td><td>27</td><td>28</td></tr> <tr><td>14</td><td>15</td><td>16</td><td>17</td><td>18</td><td>19</td><td>20</td></tr> <tr><td>29</td><td></td><td></td><td></td><td></td><td></td><td></td></tr> <tr><td>21</td><td></td><td></td><td></td><td></td><td></td><td></td></tr> </tbody> </table>	S	S	M	T	W	T	F	1	2	3	4	5	6	7	24	25	26	27	28	29	30	8	9	10	11	12	13	14	31	1	2	3	4	5	6	15	16	17	18	19	20	21	7	8	9	10	11	12	13	22	23	24	25	26	27	28	14	15	16	17	18	19	20	29							21							<p style="text-align: center;">Jumaadi II 1433 Apr - May 2012</p> <table border="1"> <thead> <tr><th>S</th><th>S</th><th>M</th><th>T</th><th>W</th><th>T</th><th>F</th></tr> </thead> <tbody> <tr><td></td><td>1</td><td>2</td><td>3</td><td>4</td><td>5</td><td>6</td></tr> <tr><td></td><td>22</td><td>23</td><td>24</td><td>25</td><td>26</td><td>27</td></tr> <tr><td>7</td><td>8</td><td>9</td><td>10</td><td>11</td><td>12</td><td>13</td></tr> <tr><td>28</td><td>29</td><td>30</td><td>1</td><td>2</td><td>3</td><td>4</td></tr> <tr><td>14</td><td>15</td><td>16</td><td>17</td><td>18</td><td>19</td><td>20</td></tr> <tr><td>5</td><td>6</td><td>7</td><td>8</td><td>9</td><td>10</td><td>11</td></tr> <tr><td>21</td><td>22</td><td>23</td><td>24</td><td>25</td><td>26</td><td>27</td></tr> <tr><td>12</td><td>13</td><td>14</td><td>15</td><td>16</td><td>17</td><td>18</td></tr> <tr><td>28</td><td>29</td><td>30</td><td></td><td></td><td></td><td></td></tr> <tr><td>19</td><td>20</td><td>21</td><td></td><td></td><td></td><td></td></tr> </tbody> </table>	S	S	M	T	W	T	F		1	2	3	4	5	6		22	23	24	25	26	27	7	8	9	10	11	12	13	28	29	30	1	2	3	4	14	15	16	17	18	19	20	5	6	7	8	9	10	11	21	22	23	24	25	26	27	12	13	14	15	16	17	18	28	29	30					19	20	21																		
S	S	M	T	W	T	F																																																																																																																																																																																																																																																	
					1	2																																																																																																																																																																																																																																																	
					23	24																																																																																																																																																																																																																																																	
3	4	5	6	7	8	9																																																																																																																																																																																																																																																	
25	26	27	28	29	1	2																																																																																																																																																																																																																																																	
10	11	12	13	14	15	16																																																																																																																																																																																																																																																	
3	4	5	6	7	8	9																																																																																																																																																																																																																																																	
17	18	19	20	21	22	23																																																																																																																																																																																																																																																	
10	11	12	13	14	15	16																																																																																																																																																																																																																																																	
24	25	26	27	28	29	30																																																																																																																																																																																																																																																	
17	18	19	20	21	22	23																																																																																																																																																																																																																																																	
S	S	M	T	W	T	F																																																																																																																																																																																																																																																	
1	2	3	4	5	6	7																																																																																																																																																																																																																																																	
24	25	26	27	28	29	30																																																																																																																																																																																																																																																	
8	9	10	11	12	13	14																																																																																																																																																																																																																																																	
31	1	2	3	4	5	6																																																																																																																																																																																																																																																	
15	16	17	18	19	20	21																																																																																																																																																																																																																																																	
7	8	9	10	11	12	13																																																																																																																																																																																																																																																	
22	23	24	25	26	27	28																																																																																																																																																																																																																																																	
14	15	16	17	18	19	20																																																																																																																																																																																																																																																	
29																																																																																																																																																																																																																																																							
21																																																																																																																																																																																																																																																							
S	S	M	T	W	T	F																																																																																																																																																																																																																																																	
	1	2	3	4	5	6																																																																																																																																																																																																																																																	
	22	23	24	25	26	27																																																																																																																																																																																																																																																	
7	8	9	10	11	12	13																																																																																																																																																																																																																																																	
28	29	30	1	2	3	4																																																																																																																																																																																																																																																	
14	15	16	17	18	19	20																																																																																																																																																																																																																																																	
5	6	7	8	9	10	11																																																																																																																																																																																																																																																	
21	22	23	24	25	26	27																																																																																																																																																																																																																																																	
12	13	14	15	16	17	18																																																																																																																																																																																																																																																	
28	29	30																																																																																																																																																																																																																																																					
19	20	21																																																																																																																																																																																																																																																					
<p style="text-align: center;">Rajab 1433 May - Jun 2012</p> <table border="1"> <thead> <tr><th>S</th><th>S</th><th>M</th><th>T</th><th>W</th><th>T</th><th>F</th></tr> </thead> <tbody> <tr><td></td><td></td><td></td><td>1</td><td>2</td><td>3</td><td>4</td></tr> <tr><td></td><td></td><td></td><td>22</td><td>23</td><td>24</td><td>25</td></tr> <tr><td>5</td><td>6</td><td>7</td><td>8</td><td>9</td><td>10</td><td>11</td></tr> <tr><td>26</td><td>27</td><td>28</td><td>29</td><td>30</td><td>31</td><td>1</td></tr> <tr><td>12</td><td>13</td><td>14</td><td>15</td><td>16</td><td>17</td><td>18</td></tr> <tr><td>2</td><td>3</td><td>4</td><td>5</td><td>6</td><td>7</td><td>8</td></tr> <tr><td>19</td><td>20</td><td>21</td><td>22</td><td>23</td><td>24</td><td>25</td></tr> <tr><td>9</td><td>10</td><td>11</td><td>12</td><td>13</td><td>14</td><td>15</td></tr> <tr><td>26</td><td>27</td><td>28</td><td>29</td><td>30</td><td></td><td></td></tr> <tr><td>16</td><td>17</td><td>18</td><td>19</td><td>20</td><td></td><td></td></tr> </tbody> </table>	S	S	M	T	W	T	F				1	2	3	4				22	23	24	25	5	6	7	8	9	10	11	26	27	28	29	30	31	1	12	13	14	15	16	17	18	2	3	4	5	6	7	8	19	20	21	22	23	24	25	9	10	11	12	13	14	15	26	27	28	29	30			16	17	18	19	20			<p style="text-align: center;">SHa' baan 1433 Jun - Jul 2012</p> <table border="1"> <thead> <tr><th>S</th><th>S</th><th>M</th><th>T</th><th>W</th><th>T</th><th>F</th></tr> </thead> <tbody> <tr><td></td><td></td><td></td><td></td><td></td><td>1</td><td>2</td></tr> <tr><td></td><td></td><td></td><td></td><td></td><td>21</td><td>22</td></tr> <tr><td>3</td><td>4</td><td>5</td><td>6</td><td>7</td><td>8</td><td>9</td></tr> <tr><td>23</td><td>24</td><td>25</td><td>26</td><td>27</td><td>28</td><td>29</td></tr> <tr><td>10</td><td>11</td><td>12</td><td>13</td><td>14</td><td>15</td><td>16</td></tr> <tr><td>30</td><td>1</td><td>2</td><td>3</td><td>4</td><td>5</td><td>6</td></tr> <tr><td>17</td><td>18</td><td>19</td><td>20</td><td>21</td><td>22</td><td>23</td></tr> <tr><td>7</td><td>8</td><td>9</td><td>10</td><td>11</td><td>12</td><td>13</td></tr> <tr><td>24</td><td>25</td><td>26</td><td>27</td><td>28</td><td>29</td><td></td></tr> <tr><td>14</td><td>15</td><td>16</td><td>17</td><td>18</td><td>19</td><td></td></tr> </tbody> </table>	S	S	M	T	W	T	F						1	2						21	22	3	4	5	6	7	8	9	23	24	25	26	27	28	29	10	11	12	13	14	15	16	30	1	2	3	4	5	6	17	18	19	20	21	22	23	7	8	9	10	11	12	13	24	25	26	27	28	29		14	15	16	17	18	19		<p style="text-align: center;">RamaDHaan 1433 Jul - Aug 2012</p> <table border="1"> <thead> <tr><th>S</th><th>S</th><th>M</th><th>T</th><th>W</th><th>T</th><th>F</th></tr> </thead> <tbody> <tr><td></td><td></td><td></td><td></td><td></td><td></td><td>1</td></tr> <tr><td></td><td></td><td></td><td></td><td></td><td></td><td>20</td></tr> <tr><td>2</td><td>3</td><td>4</td><td>5</td><td>6</td><td>7</td><td>8</td></tr> <tr><td>21</td><td>22</td><td>23</td><td>24</td><td>25</td><td>26</td><td>27</td></tr> <tr><td>9</td><td>10</td><td>11</td><td>12</td><td>13</td><td>14</td><td>15</td></tr> <tr><td>28</td><td>29</td><td>30</td><td>31</td><td>1</td><td>2</td><td>3</td></tr> <tr><td>16</td><td>17</td><td>18</td><td>19</td><td>20</td><td>21</td><td>22</td></tr> <tr><td>4</td><td>5</td><td>6</td><td>7</td><td>8</td><td>9</td><td>10</td></tr> <tr><td>23</td><td>24</td><td>25</td><td>26</td><td>27</td><td>28</td><td>29</td></tr> <tr><td>11</td><td>12</td><td>13</td><td>14</td><td>15</td><td>16</td><td>17</td></tr> <tr><td>30</td><td></td><td></td><td></td><td></td><td></td><td></td></tr> <tr><td>18</td><td></td><td></td><td></td><td></td><td></td><td></td></tr> </tbody> </table>	S	S	M	T	W	T	F							1							20	2	3	4	5	6	7	8	21	22	23	24	25	26	27	9	10	11	12	13	14	15	28	29	30	31	1	2	3	16	17	18	19	20	21	22	4	5	6	7	8	9	10	23	24	25	26	27	28	29	11	12	13	14	15	16	17	30							18						
S	S	M	T	W	T	F																																																																																																																																																																																																																																																	
			1	2	3	4																																																																																																																																																																																																																																																	
			22	23	24	25																																																																																																																																																																																																																																																	
5	6	7	8	9	10	11																																																																																																																																																																																																																																																	
26	27	28	29	30	31	1																																																																																																																																																																																																																																																	
12	13	14	15	16	17	18																																																																																																																																																																																																																																																	
2	3	4	5	6	7	8																																																																																																																																																																																																																																																	
19	20	21	22	23	24	25																																																																																																																																																																																																																																																	
9	10	11	12	13	14	15																																																																																																																																																																																																																																																	
26	27	28	29	30																																																																																																																																																																																																																																																			
16	17	18	19	20																																																																																																																																																																																																																																																			
S	S	M	T	W	T	F																																																																																																																																																																																																																																																	
					1	2																																																																																																																																																																																																																																																	
					21	22																																																																																																																																																																																																																																																	
3	4	5	6	7	8	9																																																																																																																																																																																																																																																	
23	24	25	26	27	28	29																																																																																																																																																																																																																																																	
10	11	12	13	14	15	16																																																																																																																																																																																																																																																	
30	1	2	3	4	5	6																																																																																																																																																																																																																																																	
17	18	19	20	21	22	23																																																																																																																																																																																																																																																	
7	8	9	10	11	12	13																																																																																																																																																																																																																																																	
24	25	26	27	28	29																																																																																																																																																																																																																																																		
14	15	16	17	18	19																																																																																																																																																																																																																																																		
S	S	M	T	W	T	F																																																																																																																																																																																																																																																	
						1																																																																																																																																																																																																																																																	
						20																																																																																																																																																																																																																																																	
2	3	4	5	6	7	8																																																																																																																																																																																																																																																	
21	22	23	24	25	26	27																																																																																																																																																																																																																																																	
9	10	11	12	13	14	15																																																																																																																																																																																																																																																	
28	29	30	31	1	2	3																																																																																																																																																																																																																																																	
16	17	18	19	20	21	22																																																																																																																																																																																																																																																	
4	5	6	7	8	9	10																																																																																																																																																																																																																																																	
23	24	25	26	27	28	29																																																																																																																																																																																																																																																	
11	12	13	14	15	16	17																																																																																																																																																																																																																																																	
30																																																																																																																																																																																																																																																							
18																																																																																																																																																																																																																																																							
<p style="text-align: center;">SHawwal 1433 Aug - Sep 2012</p> <table border="1"> <thead> <tr><th>S</th><th>S</th><th>M</th><th>T</th><th>W</th><th>T</th><th>F</th></tr> </thead> <tbody> <tr><td></td><td>1</td><td>2</td><td>3</td><td>4</td><td>5</td><td>6</td></tr> <tr><td></td><td>19</td><td>20</td><td>21</td><td>22</td><td>23</td><td>24</td></tr> <tr><td>7</td><td>8</td><td>9</td><td>10</td><td>11</td><td>12</td><td>13</td></tr> <tr><td>25</td><td>26</td><td>27</td><td>28</td><td>29</td><td>30</td><td>31</td></tr> <tr><td>14</td><td>15</td><td>16</td><td>17</td><td>18</td><td>19</td><td>20</td></tr> <tr><td>1</td><td>2</td><td>3</td><td>4</td><td>5</td><td>6</td><td>7</td></tr> <tr><td>21</td><td>22</td><td>23</td><td>24</td><td>25</td><td>26</td><td>27</td></tr> <tr><td>8</td><td>9</td><td>10</td><td>11</td><td>12</td><td>13</td><td>14</td></tr> <tr><td>28</td><td>29</td><td></td><td></td><td></td><td></td><td></td></tr> <tr><td>15</td><td>16</td><td></td><td></td><td></td><td></td><td></td></tr> </tbody> </table>	S	S	M	T	W	T	F		1	2	3	4	5	6		19	20	21	22	23	24	7	8	9	10	11	12	13	25	26	27	28	29	30	31	14	15	16	17	18	19	20	1	2	3	4	5	6	7	21	22	23	24	25	26	27	8	9	10	11	12	13	14	28	29						15	16						<p style="text-align: center;">Thu al-Qi' dah 1433 Sep - October 2012</p> <table border="1"> <thead> <tr><th>S</th><th>S</th><th>M</th><th>T</th><th>W</th><th>T</th><th>F</th></tr> </thead> <tbody> <tr><td></td><td></td><td>1</td><td>2</td><td>3</td><td>4</td><td>5</td></tr> <tr><td></td><td></td><td>17</td><td>18</td><td>19</td><td>20</td><td>21</td></tr> <tr><td>6</td><td>7</td><td>8</td><td>9</td><td>10</td><td>11</td><td>12</td></tr> <tr><td>22</td><td>23</td><td>24</td><td>25</td><td>26</td><td>27</td><td>28</td></tr> <tr><td>13</td><td>14</td><td>15</td><td>16</td><td>17</td><td>18</td><td>19</td></tr> <tr><td>29</td><td>30</td><td>1</td><td>2</td><td>3</td><td>4</td><td>5</td></tr> <tr><td>20</td><td>21</td><td>22</td><td>23</td><td>24</td><td>25</td><td>26</td></tr> <tr><td>6</td><td>7</td><td>8</td><td>9</td><td>10</td><td>11</td><td>12</td></tr> <tr><td>27</td><td>28</td><td>29</td><td>30</td><td></td><td></td><td></td></tr> <tr><td>13</td><td>14</td><td>15</td><td>16</td><td></td><td></td><td></td></tr> </tbody> </table>	S	S	M	T	W	T	F			1	2	3	4	5			17	18	19	20	21	6	7	8	9	10	11	12	22	23	24	25	26	27	28	13	14	15	16	17	18	19	29	30	1	2	3	4	5	20	21	22	23	24	25	26	6	7	8	9	10	11	12	27	28	29	30				13	14	15	16				<p style="text-align: center;">Thu al-Hijjah 1433 Oct - Nov 2012</p> <table border="1"> <thead> <tr><th>S</th><th>S</th><th>M</th><th>T</th><th>W</th><th>T</th><th>F</th></tr> </thead> <tbody> <tr><td></td><td></td><td></td><td></td><td>1</td><td>2</td><td>3</td></tr> <tr><td></td><td></td><td></td><td></td><td>17</td><td>18</td><td>19</td></tr> <tr><td>4</td><td>5</td><td>6</td><td>7</td><td>8</td><td>9</td><td>10</td></tr> <tr><td>20</td><td>21</td><td>22</td><td>23</td><td>24</td><td>25</td><td>26</td></tr> <tr><td>11</td><td>12</td><td>13</td><td>14</td><td>15</td><td>16</td><td>17</td></tr> <tr><td>27</td><td>28</td><td>29</td><td>30</td><td>31</td><td>1</td><td>2</td></tr> <tr><td>18</td><td>19</td><td>20</td><td>21</td><td>22</td><td>23</td><td>24</td></tr> <tr><td>3</td><td>4</td><td>5</td><td>6</td><td>7</td><td>8</td><td>9</td></tr> <tr><td>25</td><td>26</td><td>27</td><td>28</td><td>29</td><td>30</td><td>10</td></tr> <tr><td>10</td><td>11</td><td>12</td><td>13</td><td>14</td><td>15</td><td>Days</td></tr> </tbody> </table>	S	S	M	T	W	T	F					1	2	3					17	18	19	4	5	6	7	8	9	10	20	21	22	23	24	25	26	11	12	13	14	15	16	17	27	28	29	30	31	1	2	18	19	20	21	22	23	24	3	4	5	6	7	8	9	25	26	27	28	29	30	10	10	11	12	13	14	15	Days														
S	S	M	T	W	T	F																																																																																																																																																																																																																																																	
	1	2	3	4	5	6																																																																																																																																																																																																																																																	
	19	20	21	22	23	24																																																																																																																																																																																																																																																	
7	8	9	10	11	12	13																																																																																																																																																																																																																																																	
25	26	27	28	29	30	31																																																																																																																																																																																																																																																	
14	15	16	17	18	19	20																																																																																																																																																																																																																																																	
1	2	3	4	5	6	7																																																																																																																																																																																																																																																	
21	22	23	24	25	26	27																																																																																																																																																																																																																																																	
8	9	10	11	12	13	14																																																																																																																																																																																																																																																	
28	29																																																																																																																																																																																																																																																						
15	16																																																																																																																																																																																																																																																						
S	S	M	T	W	T	F																																																																																																																																																																																																																																																	
		1	2	3	4	5																																																																																																																																																																																																																																																	
		17	18	19	20	21																																																																																																																																																																																																																																																	
6	7	8	9	10	11	12																																																																																																																																																																																																																																																	
22	23	24	25	26	27	28																																																																																																																																																																																																																																																	
13	14	15	16	17	18	19																																																																																																																																																																																																																																																	
29	30	1	2	3	4	5																																																																																																																																																																																																																																																	
20	21	22	23	24	25	26																																																																																																																																																																																																																																																	
6	7	8	9	10	11	12																																																																																																																																																																																																																																																	
27	28	29	30																																																																																																																																																																																																																																																				
13	14	15	16																																																																																																																																																																																																																																																				
S	S	M	T	W	T	F																																																																																																																																																																																																																																																	
				1	2	3																																																																																																																																																																																																																																																	
				17	18	19																																																																																																																																																																																																																																																	
4	5	6	7	8	9	10																																																																																																																																																																																																																																																	
20	21	22	23	24	25	26																																																																																																																																																																																																																																																	
11	12	13	14	15	16	17																																																																																																																																																																																																																																																	
27	28	29	30	31	1	2																																																																																																																																																																																																																																																	
18	19	20	21	22	23	24																																																																																																																																																																																																																																																	
3	4	5	6	7	8	9																																																																																																																																																																																																																																																	
25	26	27	28	29	30	10																																																																																																																																																																																																																																																	
10	11	12	13	14	15	Days																																																																																																																																																																																																																																																	

تقويم السنّة الهجرية 1433 علماً إن اليوم الإسلامي يبدأ في مغيب اليوم السابق

خطوط عرض وتواريخ أحداث 2012

13°	2012-01-07	2012-01-08	2012-01-09	2012-01-10
16°	2012-01-22	2012-01-23	2012-01-24	2012-01-25
18°	2012-01-30	2012-01-31	2012-02-01	2012-02-02
21°	2012-02-10	2012-02-11	2012-02-12	2012-02-13
23°	2012-02-18	2012-02-19	2012-02-20	2012-02-21
25°	2012-02-28	2012-02-29	2012-03-01	2012-03-02
28°	2012-03-13	2012-03-14	2012-03-15	2012-03-16
30°	2012-03-27	2012-03-28	2012-03-29	2012-03-30
32°	2012-04-04	2012-04-05	2012-04-06	2012-04-07
34°	2012-04-24	2012-04-25	2012-04-26	2012-04-27
36°	2012-05-06	2012-05-07	2012-05-08	2012-05-09
38°	2012-05-16	2012-05-17	2012-05-18	2012-05-19
40°	2012-05-28	2012-05-29	2012-05-30	2012-05-31
42°	2012-06-07	2012-06-08	2012-06-09	2012-06-10
45°	2012-06-22	2012-06-23	2012-06-24	2012-06-25
47°	2012-07-01	2012-07-02	2012-07-03	2012-07-04
49°	2012-07-07	2012-07-08	2012-07-09	2012-07-10
51°	2012-07-14	2012-07-15	2012-07-16	2012-07-17
53°	2012-07-23	2012-07-24	2012-07-25	2012-07-26
55°	2012-08-05	2012-08-06	2012-08-07	2012-08-08
57°	2012-08-18	2012-08-19	2012-08-20	2012-08-21
59°	2012-08-25	2012-08-26	2012-08-27	2012-08-28
61°	2012-09-03	2012-09-04	2012-09-05	2012-09-06
63°	2012-09-10	2012-09-11	2012-09-12	2012-09-13
65°	2012-09-15	2012-09-16	2012-09-17	2012-09-18
67°	2012-09-22	2012-09-23	2012-09-24	2012-09-25
69°	2012-09-30	2012-10-01	2012-10-02	2012-10-03
71°	2012-10-07	2012-10-08	2012-10-09	2012-10-10
73°	2012-10-15	2012-10-16	2012-10-17	2012-10-18
75°	2012-10-25	2012-10-26	2012-10-27	2012-10-28
77°	2012-11-04	2012-11-05	2012-11-06	2012-11-07

Ali Adams علي عبد الرزاق القره غولي

God > ∞ الله أكبر

Email: heliwave@yahoo.com

Web: www.heliwave.com

Disclaimer

This research does not claim to predict the End of the World. Instead, it is a scientific journey for uncovering the hidden link between the Holy Quran and prime numbers. As a side-effect, possible events that are related to the year 2012 have been discovered that can shape the human history in profound ways with God's permission.

It is only God who knows and indeed decides when the End of the World will come at the blink of an eye or even nearer as stated in Quran 16:77:

أَعُوذُ بِاللَّهِ مِنَ الشَّيْطَانِ الرَّجِيمِ بِسْمِ اللَّهِ الرَّحْمَنِ الرَّحِيمِ

وَاللَّهُ غَيْبُ السَّمَوَاتِ وَالْأَرْضِ ۗ وَمَا أَمْرُ السَّاعَةِ إِلَّا كَلَمْحِ الْبَصَرِ أَوْ هُوَ أَقْرَبُ ۗ
إِنَّ اللَّهَ عَلَىٰ كُلِّ شَيْءٍ قَدِيرٌ

*To Allah belongs the Unseen of heavens and earth
and The Hour can come at the blink of an eye, or even nearer.
Truly! Allah is capable of doing anything.*

However, minor and major signs of the End of the World were already foretold by the Prophet (pbuh+f) to warn us of the Deceiver and to be ready to fight him and his system under the banner of Imam Mehdi and Prophet Jesus (peach be upon them both).

A very clear sign the Prophet (pbuh+f) had foretold us is:

1. "You shall see the barefooted, naked, indigent shepherds compete in building tall structures."
2. "When the barefooted and the naked are the heads of the people."
3. "When you see the barefooted and naked, the deaf and dumb are the kings of the earth."

This is now can be experienced first hand in the Gulf states, for example:

- The 818m-high Burj Dubai in the UAE to be the tallest skyscraper in that has just opened on 04/01/2010 [http://en.wikipedia.org/wiki/Burj_Dubai].
- The 1000m-high Kingdom Tower in Saudi Arabia with work already started in June 2009 [http://en.wikipedia.org/wiki/Kingdom_Tower] to be the tallest ever, after Emaar abandoned The Mile Tower (1609.34m) in Jeddah, Saudi Arabia.

Indeed these are critical times, too critical to simply brush off as that would simply go against the teachings of our beloved Prophet (pbuh+f).

We must therefore be vigilant and ready to meet our Creator at any Hour.

Preface

All praise and exaltation is due to God, the Creator and Sustainer of all Seen and Unseen worlds of man (clay-based), jinn (fire-based), angel (light-based), and all that is unknown.

This book will take the reader from a state of indifference to the world around them to a new engaging state that will enable him or her to take part in shaping the future of mankind with the permission of God, Allah Almighty.

Within a few pages you shall be entrusted with new knowledge that Allah has revealed to help us prepare for the upcoming events of 2012 and beyond, both spiritually and physically.

The most important finding of this research is that the world will not end in 2012 but, with God's permission, as many as 31 minor events will occur between 7th January 2012 and 7th November 2012 before a great event shapes the history of the world and enriches humanity with new spiritual experiences beyond imagination, but only Allah knows the truth.

Get ready to ride the wave of spiritual awakening.

Acknowledgments

Praise is due to Allah, the Sustainer of all the worlds in real-time who is guiding us every step of the way with indirect clues from families, friends, colleagues and all the good people on the various Internet forums with their valuable feedback to strengthen my arguments and solidify my resolve.

Special thanks are reserved for my newly reverted wife, **Khadeeja Chen** who supported me emotionally and financially throughout this research effort when many preferred to watch from the sidelines.

But above all, this work is dedicated to my beloved children so they may benefit from it in the future, **Haider, Hasan** and **Aya**, may Allah protect them and bless them with guidance and knowledge in this life and mercy and forgiveness in the hereafter, in sha Allah.

Peace to you all.

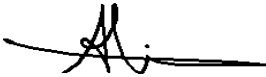
A handwritten signature in black ink, appearing to be 'Ali Adams', with a long horizontal line extending to the right.

Ali Adams

Introduction

This research is a sincere attempt at finding some hidden messages within Allah's last revelation to mankind, the Quran, by following the straight path Allah has shown us within the first chapter of his Book, *The Key* (الفتاحه).

It is not an attempt to decode the entire Quran as this is only possible for Allah and those who are well grounded in knowledge (الرَّاسِخُونَ فِي الْعِلْمِ) according to Quran 3:7:

أَعُوذُ بِاللَّهِ مِنَ الشَّيْطَانِ الرَّجِيمِ بِسْمِ اللَّهِ الرَّحْمَنِ الرَّحِيمِ

هُوَ الَّذِي أَنْزَلَ عَلَيْكَ الْكِتَابَ مِنْهُ آيَاتٌ مُحْكَمَاتٌ هُنَّ أُمُّ الْكِتَابِ وَأُخَرُ مُتَشَابِهَاتٌ مُطَهَّرَاتٌ وَالَّذِينَ فِي قُلُوبِهِمْ زَيْغٌ فَيَتَّبِعُونَ مَا تَشَابَهَ مِنْهُ ابْتِغَاءَ الْفِتْنَةِ وَابْتِغَاءَ تَأْوِيلِهِ وَمَا يَعْلَمُ تَأْوِيلَهُ إِلَّا اللَّهُ وَالرَّاسِخُونَ فِي الْعِلْمِ يَقُولُونَ آمَنَّا بِهِ كُلٌّ مِنْ عِنْدِ رَبِّنَا وَمَا يَذَّكَّرُ إِلَّا أُولُو الْأَلْبَابِ

He it is Who has revealed the Book to you; some of its verses are decisive, they are the basis of the Book, and others are allegorical; then as for those in whose hearts there is perversity they follow the part of it which is allegorical, seeking to mislead and seeking to give it (their own) interpretation. But none knows its true meaning except Allah and those well grounded in knowledge. They say, "We believe in it all, all of it is from our Lord." And only those who have the seeds of intelligence will take heed.

Those "well grounded in knowledge" are the Prophet and his disciples may peace be upon them all. They are *The People of The House of Knowledge* who receive their knowledge directly from Allah; while those who are *blessed with the seed of intelligence* (أُولُو الْأَلْبَابِ) need to follow their teachings to gain any useful knowledge for mankind. May Allah guide us to be sincere servants of Him and hopefully worthy members of such an exclusive club, God willing.

The vast amounts of knowledge within the Quran is encoded in layers upon layers of knowledge, each containing hidden knowledge and further keys to unlocking all layers beneath it. Allah Almighty says in Quran 18:109:

أَعُوذُ بِاللَّهِ مِنَ الشَّيْطَانِ الرَّجِيمِ بِسْمِ اللَّهِ الرَّحْمَنِ الرَّحِيمِ

قُلْ لَوْ كَانَ الْبَحْرُ مِدَادًا لَكَلِمَاتِ رَبِّي لَنَفَذَ الْبَحْرُ قَبْلَ أَنْ تَنْفَذَ كَلِمَاتِ رَبِّي لَوْ جِئْنَا بِمِثْلِهِ مَدَدًا

"Say, If the ocean were ink for the words of my Lord, the ocean would run out, before the words of my Lord run out, even if we double the ink supply."

Without a doubt a 604-page book would not need that much ink. That virtual ink is needed for the countless implicit meanings behind each verse of the Quran.

Only with Allah's permission and continuous **hints** from Him and His Prophet and disciples (peace be upon them), one may learn how to unlock any layer(s) of the Quran when Allah deems it right for that time.

For example, in the story of the “**Youths of the Cave**” there is a Quranic verse that shows at least two layers of hidden knowledge in Quran 18:25:

أَعُوذُ بِاللَّهِ مِنَ الشَّيْطَانِ الرَّجِيمِ بِسْمِ اللَّهِ الرَّحْمَنِ الرَّحِيمِ

وَلَبِثُوا فِي كَهْفِهِمْ ثَلَاثَ مِائَةٍ سِنِينَ وَازْدَادُوا تِسْعًا
*And they stayed (asleep) in their Cave for
three hundred years and add nine more.*

One of these hidden knowledge is that Allah chose to split the 309 years into 300 plus 9 for the benefit of both accuracy (الضبطاۃ how close to the real value) and precision (الدقة how small are the divisions of measurement are).

[<http://sofmosul.ektob.com/92956.html> and

<http://honolulu.hawaii.edu/distance/sci122/SciLab/L5/accprec.html>].

To understand the difference between these two important concepts, take for example two watches, one displaying 8:31 while the other displaying 8:29:07 when the actual time is 8:30:59. While the first watch is more accurate (closer to reality), the second is more precise (because it displays time to the precision of seconds not minutes like the first one) but nevertheless is not very accurate.

When the Jews heard of the above verse they came to the Prophet (pbuh+f) and asked how long did the youths stay in their cave in hibernation as it was not obvious if the 309 years are solar or lunar years? The Prophet (pbuh+f) answered that it was 300 solar years!

Simply and elegantly put by Allah All-knowing, 300 solar years equals 309 lunar years with a 0.066% difference based on our current scientific time measurements as shown here:

300 solar years × 365.24219 days / solar year ≈ 109572.66 days
309 lunar years × 354.37 days / lunar year ≈ 109500.33 days

Error ratio = (109572.66 – 109500.33) / 109572.66 ≈ 0.00066

The precise and hopefully accurate days per year data were taken from “*Summary of various kinds of year*”.

[http://en.wikipedia.org/wiki/Year#Summary_of_various_kinds_of_year].

Days of Various Year Kinds

- **354.37** days (12 lunar months): the average length of a year in **lunar calendars**.
- **365.24219** days: **a mean tropical year near the year 2000**.
- 365.2424 days: a vernal equinox year.
- 365.2564 days: a sidereal year.
- 365 days: a common year in many solar calendars.
- 366 days: a leap year in many solar calendars.
- 365.2425 days: the average length of a year in the Gregorian calendar.
- 365.25 days: the average length of a year in the Julian calendar.
- 353, 354 or 355 days: the lengths of common years in some lunisolar calendars.
- 383, 384 or 385 days: the lengths of leap years in some lunisolar calendars.
- 383.9 days (13 lunar months): a leap year in some lunisolar calendars.
- 346.62 days: a draconitic year in some septenary calendars.

That was the first layer uncovered by the Prophet (pbuh+f). The second layer of hidden knowledge can uncover the exact time of the story by trying to find out when 300 solar years equaled **exactly** 309 lunar years because the average days in a year changes slowly over time (see the above “**a mean tropical year near the year 2000**”). Such valuable knowledge would help us instantly calibrate many other events in accordance with their chronological order (a third layer of knowledge if you will), and Allah knows best.

This verse is a clear example of Allah All-knowing hiding more information in His text than meets the eyes and it is our responsibility as Quran Scientists to try to extract such secrets using all linguistic, numeric, and scientific tools with the permission and blessings of Allah.

Glory to Him, the first such blessing came when Allah Almighty showed me a direct link between the first chapter of the Quran (The Key **الفتاحة**) and number theory and in particular, prime numbers (or indivisible numbers **الوتر**). As a result, a new numerology system based on prime numbers was developed and successfully applied to the letters of the chapter which produced the prime evidence of the correctness of this new system to be called, **Primology**.

Prime numbers are not the only means to unlock the hidden secrets within the message of the Quran. Other transcendental numbers such as π , Euler's natural logarithm base e and the golden ratio ϕ as well as Fibonacci numbers may also be used to unlock more secrets with Allah's permission.

This research however, focuses exclusively on prime numbers as they represent the basic building blocks for all other natural numbers as any non-prime number is simply a product of prime number by multiplication.

While the density of prime numbers within natural numbers decreases in a predictable logarithmic fashion, their distribution does not follow any known pattern and is so mysterious that there is \$1,000,000 prize for whoever finds that pattern or mathematically proves that there is no pattern. The distribution of prime numbers seems neither random nor predictable.

Due to their unbreakable mystery, prime numbers are considered God's signature in the Universe and hence The Key chapter can be considered as the signature of Allah Almighty for the Quran to show its divine origin. Moreover, as recent as the 1970s, the distribution of prime numbers was found to be closely related to the distribution of energy levels of electrons orbiting their atomic shells, especially in heavy elements like Uranium.

Not only are prime numbers the signature of Allah All-knowing, but He has deliberately used them to protect the inner knowledge of His everlasting message the Quran! To make it even more secure, Allah has used a specific kind of primes that have prime digit sums too called *Additive Primes* [<http://www.research.att.com/~njas/sequences/A046704>].

This research suggests that the Quran consists of two parts, a **Key** part (chapter The Key) and a **Message** part (the remaining 113 chapters). This suggestion is supported both mathematically using additive primes and scientifically using the sequence number of chapter The Iron (الحديد).

Primology was also applied to the letters of chapter #112, Oneness of God (الإخلاص) and amazingly produced additive primes *with* and *without* Bism Allah Ar-Rahmaan Ar-Raheem confirming its status as a prefix verse without number, unlike the mandatory verse #1 of chapter The Key.

Finally, chapter #55 of the Quran, The Merciful (الرحمن) was investigated for its oft-repeated verse (فَيَأْتِيَّ آءَالَاءُ رَبِّكُمَا تُكَذِّبَانِ) and produced the most revealing finding this research has achieved to date, hidden references to the years **2012** and **2192**. that were confirmed by number of words in the chapter.

Prime Numbers

Natural numbers are all positive integers from 1 to infinity (∞). They are divided into two groups, **odd numbers** that are not evenly divisible by 2 (e.g. 1, 3, 5, 7, 9, 11, 13, 15, 17, 19, 21, 23...) and **even numbers** that are evenly divisible by 2 (e.g. 2, 4, 6, 8, 10, 12, 14, 16, 18, 20, 22, 24...).

In general, numbers are divided into two categories based on their divisibility by other numbers, not just by 2. All natural numbers that are indivisible by any other number are called **prime numbers** (e.g. 2, 3, 5, 7, 11, ...), and all other numbers are called **composite numbers** (e.g. 4, 6, 8, 9, 10, 12, ...) because they can be composed by multiplying prime numbers together called prime factors or prime divisors. For example, factoring the composite 24 into its prime factors is shown here:

$$\begin{array}{ll}
 24 = 2 \times 12 & 12 \text{ can be further divided} \\
 = 2 \times 2 \times 6 & 6 \text{ can be further divided} \\
 = 2 \times 2 \times 2 \times 3 & \text{No further division is possible} \\
 = 2^3 \times 3^1 & \text{Here are the prime factors of } 12
 \end{array}$$

Prime numbers are truly the **atoms** of mathematics while composite numbers are the **molecules** that are composed of various atoms. Therefore, prime numbers are said to be the multiplicative building blocks for all natural numbers, including themselves as primes simply equal themselves.

Note that divisibility by 1 never divides any number into smaller parts and thus is merely a mathematical abstract without physical meaning. This is why this research defines prime numbers as “*not divisible by any other numbers*” as God intended, rather than the mathematical definition of “*divisible by 1 and themselves only*”, which was later changed to “*have two distinct factors, 1 and themselves*” which deliberately excludes 1 as a prime number and eases the fundamental theorem of arithmetic. Therefore, the number **1** became a special case, neither a prime nor a composite number but **the unit** or the additive building block for all natural numbers, primes or composites (e.g. $3 = 1+1+1$, $4 = 1+1+1+1$).

1 is the **proton** of mathematics that determines atomic numbers of all the elements in nature and hence their identity (e.g. ¹Hydrogen, ²Helium, ³Lithium, ⁴Beryllium, ⁵Boron, ⁶Carbon, ⁷Nitrogen, ⁸Oxygen, ⁹Fluorine, ¹⁰Neon, ¹¹Sodium, ¹²Magnesium, ¹³Aluminum, ..., ¹¹³Ununtrium).

Primality of 1

The arguments for and against the primality of 1 are still raging, see [<http://primefan.tripod.com/Prime1ProCon.html>]. This research gives two new arguments for reinstating number 1 to be a prime number just as was the case in all previous centuries.

The first argument can be seen by examining the series of natural numbers from 1 to 10 where every prime number is mirrored by a composite number and vice versa as shown here:

1	2	3	4	5	6	7	8	9	10
---	---	---	---	---	---	---	---	---	----

1, 2, 3 are mirrored by 10, 9, 8 respectively, 4 is mirrored by 7, and 5 is mirrored by 6. This mirror symmetry about the center would not have existed if number 1 was not a prime.

The second argument for the primality of number 1 can be found deep within the human genome [<http://en.wikipedia.org/wiki/Genome>] as its number of our chromosome pairs of 23. Amazingly, concatenating all prime numbers from 1 to 23 left-to-right (**123571113171923**) and right-to-left (**231917131175321**) produces primes and their digit sums of $1+2+3+5+7+1+1+1+3+1+7+1+9+2+3 = 2+3+1+9+1+7+1+3+1+1+7+5+3+2+1 = 47$ are also primes making them additive primes. Without number 1 this numeric symmetry would not have existed.

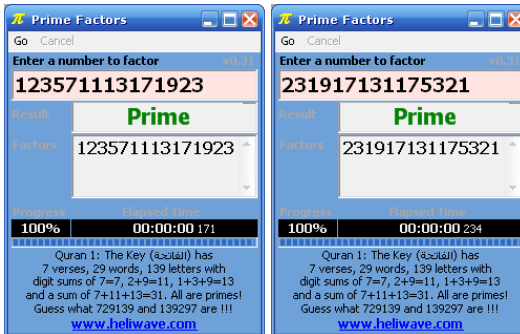

Prime Factorization of 123571113171923 and 231917131175321

Not only is number 1 indivisible by other numbers, it is not even divisible by itself and therefore is the *indivisible unit* of numbers, enforcing its status as the purest of all primes. Number 1 is truly a **pure prime**.

Prime Number History

Around 300BC, **Euclid**, *the Father of Geometry*, [<http://en.wikipedia.org/wiki/Euclid>] proved there is an infinite number of prime numbers [<http://primes.utm.edu/notes/proofs/infinite/euclids.html>].

In 230BC, **Eratosthenes** [<http://en.wikipedia.org/wiki/Eratosthenes>] developed a sieve method for filtering prime numbers below any number N by sequentially removing all numbers that are multiples of prime numbers less or equal to the square root of N [http://en.wikipedia.org/wiki/Sieve_of_Eratosthenes]. It was a clever method that does not use division which is very slow, but instead it keeps on skipping a constant gap and crossing out whatever number it lands on.

For example, to find all the prime numbers below N=100, all you need to do is circle the first number n = 2 (1 is ignored) and skip n numbers to 4 and cross it out and then skip n numbers to 6 and cross it out and so on until 100, then find the next uncrossed number which will be n = 3 and circle it and then skip n numbers to 6 and cross it out then to 9, 12, 15, ..., 99, and then find the next uncrossed number and repeat the same steps until $n \leq \sqrt{N}$. At the end, all circled and uncrossed numbers are the set of primes below N.

In 1793, Carl **Gauss**, *the Prince of Mathematics*, who reportedly once said "*Mathematics is the queen of the sciences and number theory is the queen of mathematics.*" [http://en.wikiquote.org/wiki/Carl_Friedrich_Gauss] predicted that the density ratio of prime numbers decreases logarithmically [$1/\ln(N)$] as we count higher and higher but never diminishes to zero, which turned out to be *almost true* but not quite so as seen from the error term in the following table.

N	Primes	Actual Density	Predicted Density	Error
100	25	25.0 %	21.7 %	3.3 %
1,000	168	16.8 %	14.5 %	2.3 %
1,000,000	78,498	7.9 %	7.2 %	0.7 %
1,000,000,000	50,847,534	5.1 %	4.8 %	0.3 %
1,000,000,000,000	37,607,912,018	3.8 %	3.6 %	0.2 %
1,000,000,000,000,000	29,844,570,422,669	3.0 %	2.89 %	0.11 %

Density of Prime Numbers within Natural Numbers

Although the density ratio of prime numbers follows a predictable pattern, their distribution among natural numbers follows no known pattern.

In 1859, Bernard **Riemann** [http://en.wikipedia.org/wiki/Bernhard_Riemann] proposed his Riemann Hypothesis [http://en.wikipedia.org/wiki/Riemann_hypothesis] with a new zeta function to correct the error in Gauss' prediction but never proved it.

The **Riemann Hypothesis** is one of the great unanswered questions in mathematics today with \$1,000,000 prize money to whoever proves or disproves it by the Clay Mathematics Institute, Cambridge, Massachusetts, USA [<http://www.claymath.org/millennium>]. Riemann generalized the harmonic series [[http://en.wikipedia.org/wiki/Harmonic_series_\(mathematics\)](http://en.wikipedia.org/wiki/Harmonic_series_(mathematics))] to complex numbers ($z = x + i y$) domain as follows:

$$\zeta(z) = \frac{1}{1^z} + \frac{1}{2^z} + \frac{1}{3^z} + \frac{1}{4^z} + \frac{1}{5^z} + \dots$$

Riemann Zeta Function

Using mathematical analysis it was proven that Riemann's Zeta function equals to Euler Product formula as shown here:

[http://en.wikipedia.org/wiki/Proof_of_the_Euler_product_formula_for_the_Riemann_zeta_function]

$$\frac{1}{1^z} + \frac{1}{2^z} + \frac{1}{3^z} + \frac{1}{4^z} + \frac{1}{5^z} + \dots = \frac{1}{1 - \frac{1}{2^z}} \times \frac{1}{1 - \frac{1}{3^z}} \times \frac{1}{1 - \frac{1}{5^z}} \times \frac{1}{1 - \frac{1}{7^z}} \times \frac{1}{1 - \frac{1}{11^z}} \dots$$

Riemann Zeta Function and Euler Product Formula

This magical relationship links a series of natural numbers on the one hand to a series of prime numbers on the other. It has such deep implications for the prime number distribution that Derbyshire, in his book *Prime Obsession* (2003) named the *Golden Key*.

$$\sum_n \frac{1}{n^z} = \prod_p \frac{1}{1 - \frac{1}{p^z}}$$

The Golden Key

Until recently, prime numbers were thought to be mere magical numbers with no real use outside mathematics and number theory. In 1972 however, **Hugh Montgomery** (mathematician) and **Freeman Dyson** (physicist) [http://seedmagazine.com/content/article/prime_numbers_get_hitched] after a chance meeting over a coffee break discovered an amazing new relationship between the distribution of Riemann's zeta function and the distribution of energy levels of electron orbits in heavy atoms like Uranium. [<http://arifatmath.co.uk/section4.html>].

This was a major breakthrough for number theorists to justify their research and in 2008, two quantum physicists, German **Sierra** from the Spanish National Research Council and Paul **Townsend** from Cambridge University, U.K. boldly exclaimed that: **“A single electron might know more about numbers than all of the mathematicians in world.”**

They claimed that when an electron is confined to moving in only two dimensions, the possible energy levels it can take seem to follow a pattern that is similar to what is proposed by the unproven-yet Riemann Hypothesis. [<http://www.thefreelibrary.com/Quantum+physics+may+offer+clues+to+solving+prime+number+problem:...-a0186320999>].

Cryptography

Every time you buy something over the Internet with a credit card (using [https](#) – **secure** *hypertext transfer protocol*), large prime numbers are used to keep your financial information secure using *cryptography*.

Cryptography (Greek *kryptos* hidden, *graphein* to write) is the science of converting messages into ciphered text so they cannot be read by anyone except the intended recipient [<http://www.claymath.org/posters/primes/>]. This process is known as ciphering, encoding, or simply encryption and makes use of either *private key cryptography* or *public key cryptography*.

Private key cryptography employs one key per party (sender or recipient) to communicate a message securely. In this system, a sender encodes a message using his own key (k_1) and sends it to the intended recipient. The recipient then further encodes the message with his own key (k_2) and returns the now doubly encoded message back to the sender. The sender then decodes it using his k_1 key and re-sends it back to the recipient who can now decode it using his k_2 key and finally be able to view its content. No party needs to know the other party's key so both keys remain private.

Public key cryptography on the other hand employs two separate keys per each party (sender or recipient) [http://www.livinginternet.com/i/is_crypt_pkc_work.htm]; a public key used for encryption and is known to everyone and a private key used for decrypting and is known only to the recipient party. These keys are based on prime numbers; two very large ones to be exact (hundreds of digits long). Multiplying these two prime numbers produces a huge number that is only divisible by the two prime numbers. This huge number then processed and published as the public key to enable senders to encrypt messages to send specifically to the owner of this public key. The prime numbers themselves are kept private and together are considered as the private key needed to decrypt the message [http://www.webopedia.com/term/p/public_key_cryptography.html].

Although public keys are shared publically, factoring one into its two prime factors is a very lengthy process (e.g. 128-bit encryption requires years of current computing power) [http://www.cpaadvisor.us/sub/8_encryption.htm].

If stronger security is required, then using carefully selected types of prime numbers can make it even harder to decrypt messages. This is why perhaps Allah has chosen additive primes to secure His Message along with very hard and uncommon Arabic spellings, and Allah is indeed All-knowing.

Research Methodology

This research proposes and complies with the following rules:

1. The Quran is the final Word of Allah to mankind and jinnkind and is always protected by Him throughout time.
2. The Quran is the book with the recitation method of **Hafs** (قراءة حفص) and the scripting/writing method of **Uthmani** (الرسم العثماني).
3. The decimal (**base10**) system is the system to be used for prime number studies of the Holy Text as per Quran 89:1–5

أعوذ بالله من الشيطان الرجيم بسم الله الرحمن الرحيم

- | | |
|--|---|
| 1. By the dawn. | 1. وَالْفَجْرِ |
| 2. By the ten nights. | 2. وَلَيَالٍ عَشْرٍ |
| 3. By the divisible (composite) and the indivisible (prime). | 3. وَالشَّعْرِ وَالْوُزْرِ |
| 4. By the night as it eases away. | 4. وَاللَّيْلِ إِذَا يَسْرِ |
| 5. Isn't that a big enough oath for he who can think? | 5. هَلْ فِي ذَلِكَ قَسَمٌ لِّذِي حَبْرِ |

[Interpreted by Ali Adams]

4. The definition of a word is one or more letters followed by a space character. The English word “**and**” is represented in Arabic by a single letter “**و**” that is always connected to the word that follows it and hence becomes part of it not an independent word by itself.
5. The Arabic standalone hamza (ء) as in the word (الْفَرْعَانِ) is considered as an independent letter and therefore the Arabic language is considered to use **29 letters** instead of 28 [<http://en.wikipedia.org/wiki/Hamza>].
The standalone hamza is considered to precede the elf (ا) in the alphabetical order just as it precedes it in the word (الْفَرْعَانِ).
6. If a mathematical proof is found to fit almost all of the Quranic text but not exactly all. We **must never ever** ask to change the Quranic text to fit our theory. This is a classic case where Allah Almighty is testing the strength of our belief in Him against our belief in math and science that after all are all created by Him. Mathematics is **not perfect** as it had to be fixed by making $0^0 = 1$ and $0! = 1$ to stay internally consistent. This man-made fix may sadly be preventing us from seeing more into reality. Just ask superstring theorists [www.superstringtheory.com] who ended up with **five** different solutions to what reality might be that are all internally consistent but not externally consistent with each other.

7. When manipulating numbers, the following operations are **allowed**:
- the value of a number must be represented in decimal system.
 - the arithmetic operations $+$, \times for two or more numbers of the same kind (e.g. verses number with verse numbers, digit sums with digit sums, primalogy values with primalogy values, etc. No mix and match is allowed).
 - the arithmetic operations $-$, \div for two numbers of the same kind.
 - the arithmetic operations \wedge , $!$, $\sqrt{\quad}$ for a single number.
 - is the number divisible (composite) or indivisible (prime)?
 - if divisible, the number prime factors (divisors) can be used.
 - if divisible, the values of its prime factors can be used.
 - if divisible, the sum of its prime factors can be used.
 - if divisible, the gap between its prime factors can be used.
 - the number of digits in the number, their sum, and gap between neighboring digits.
 - are all digits prime numbers? is the sum of the digits prime?
 - concatenating numbers right to left (Arabic direction) is the mandatory, left to right (Latin direction) is optional.
 - splitting numbers into digit groups of fixed size or well related sizes only (e.g. with Fibonacci, golden ratio ϕ , π or e digits gaps).
 - digits mirroring (e.g. 12345 becomes 54321) if used consistently.
 - mapping numbers to Hijri days, months, years, and dates.
 - mapping numbers to times at specified locations, or Makkah if the not specified as the Islamic Dateline passes through Makkah along the sunset horizon of that day.
 - mapping Quranic text extended sounds to values proportionally. For example in Quran 1:7 the sound lengths of the highlighted words in:

أعوذ بالله من الشيطان الرجيم بسم الله الرحمن الرحيم

“صِرَاطَ الَّذِينَ أَنْعَمْتَ عَلَيْهِمْ غَيْرِ الْمَغْضُوبِ عَلَيْهِمْ وَلَا الضَّالِّينَ”
*“The path of those whom You bestowed your bounties upon;
 not of those who have brought upon themselves Your wrath,
 nor of those who went astray”*

are 1, 1, and 6 may give a clue to the ratio of such types of people: **1/8** are good, **1/8** are bad, **6/8** are astray or misguided.

The Key Chapter

The Quran starts with a chapter called *The Opener* or *The Key* (الفاتحة) which is shown below in the standard recitation method of Hafz (قراءة حفص) and the Uthmani style of writing (الرسم العثماني):

	أعوذ بالله من الشيطان الرجيم بِسْمِ اللَّهِ الرَّحْمَنِ الرَّحِيمِ
In the name of Allah, the Merciful, the Benevolent.	بِسْمِ اللَّهِ الرَّحْمَنِ الرَّحِيمِ
All praise to Allah, Sustainer of the worlds.	الْحَمْدُ لِلَّهِ رَبِّ الْعَالَمِينَ
The Merciful, the Benevolent.	الرَّحْمَنِ الرَّحِيمِ
Master of the Day of Judgment,	مَلِكِ يَوْمِ الدِّينِ
You alone we worship; You alone we ask for help.	إِيَّاكَ نَعْبُدُ وَإِيَّاكَ نَسْتَعِينُ
Guide us to the Right Path:	اهْدِنَا الصِّرَاطَ الْمُسْتَقِيمَ
	صِرَاطَ الَّذِينَ أَنْعَمْتَ عَلَيْهِمْ غَيْرِ الْمَغْضُوبِ عَلَيْهِمْ وَلَا الضَّالِّينَ
The path of those whom You bestowed your bounties upon; not of those who have brought upon themselves Your wrath, nor of those who went astray.	

This chapter consists of 7 verses, 29 words, and 139 letters. These numbers are all primes and the sums of their digits ($7=7$, $2+9=11$, $1+3+9=13$) are primes too meaning all three (7, 29, 139) are **additive prime numbers** [<http://www.research.att.com/~njas/sequences/A046704>].

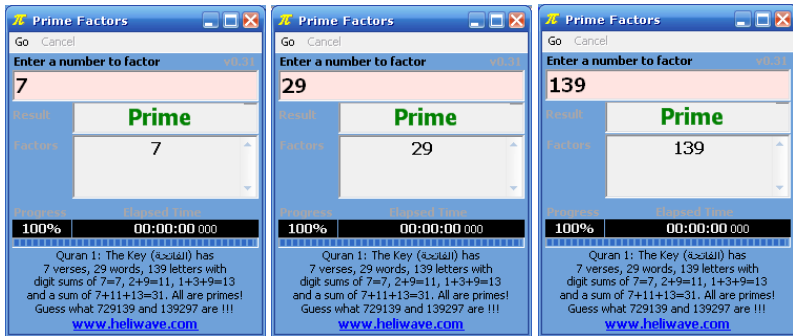

Prime Factorization of 7, 29 and 139

What's more, the sum of the digit sums ($7+11+13=31$) is another prime number! However, it is not an additive prime which may mean its role is not finished yet as it could be pointing to another significant place in the Quran as shall be seen later. I call it a *dangling pointer*. 😊

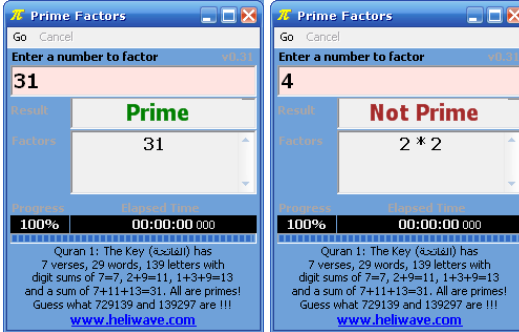

Prime Factorization of 31 and 4

After few weeks of excitement and joy for having witnessed such a revelation by Allah Almighty, and after extensive search on the Internet that confirmed what I have found to be both new and unique, I wrote a PocketPC program (*Prime Factors*) to help find out what other secrets these three prime numbers might be hiding and God behold! almost within few hours of use I found that concatenating the three prime numbers left-to-right (**729139**) and right-to-left (**139297**) also produces additive prime numbers as shown here. Of course their digit sums ($1+3+9+2+9+7=31$ and $7+2+9+1+3+9=31$) were already calculated as the hanging **31**.

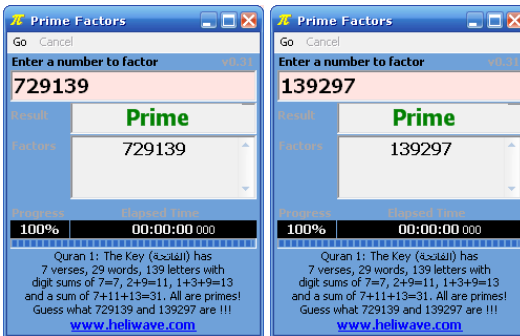

Prime Factorization of 729139 and 139297

Knowing the important role prime numbers play as keys in cryptography and seeing that Allah Almighty has named the first chapter of the Quran (الفاتحة) “The Key” or “The Opener” (but not *Introduction* as many Muslims believe), it was abundantly clear that this chapter is **the real key** to decoding the first layer of the Quran, with the permission and help of Allah, the All Knowing.

The **most significant consequence** of this revelation is that the “Bism Allah Ar-Rahmaan Ar-Raheem” of The Key chapter is unlike the prefix of all other chapters (except chapter #9 Repentance التوبة which has none), is an integral part of the chapter and that is why it is verse #1. Indeed, if this was not the case then even if the last verse was split into two to keep the verse count at 7 (as done in the recitation method of Warsh), the number of words and letters would drop to **25** and **120** respectively which are not primes (composites) let alone additive primes.

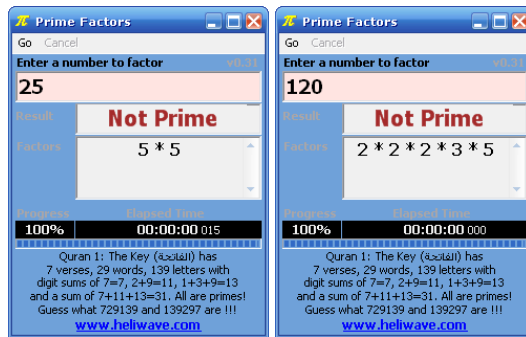

Prime Factorization of 25 and 120

The Key Verses

The number of words per Key verse (4, 4, 2, 3, 4, 3, 9) are mysterious whereas the numbers of letters in each verse are (19, 17, 12, 11, 19, 18, 43) has some pattern to it despite not all being prime numbers. Any non-prime number can combine with its neighbours on either side to produce prime numbers as follows:

$$17+12 = \mathbf{29} \quad \text{or} \quad 12+11 = \mathbf{23}$$
$$19+18 = \mathbf{37} \quad \text{or} \quad 18+43 = \mathbf{61}$$

Why should they produce such prime sums on either side?
What secrets are lurking behind this seemingly innocent neighborly love between primes and composites?

Could it hold the secret to unlocking the mystery of prime distribution? Or could it simply be a hint by Allah the All-knowing for the different ways to connect the over 70 thousand words and 300 thousand letters of the message of the Quran?

Statistic	With Diacritical Marks	Without Diacritical Marks
Pages	291	313
Words	77,878	82,456
Characters (no spaces)	328,289	632,137
Characters (with spaces)	400,147	708,357
Paragraphs	6,236	6,236
Lines	8,933	9,047
Non-Asian words	77,878	82,456
Asian characters, Korean words	0	0

Statistics for Tanzil Quran v1.0.2 with and without Diacritical Marks

WARNING:

The statistics above are most likely **incorrect** but yet are the best that can be achieved using the most accurate (but not yet authorized) softcopy of the Holy Quran available today.(July 2009) freely from www.tanzil.info.

For now, it is enough to note that concatenating the number of letters in each Key verse (**19, 17, 12, 11, 19, 18, 43**) right-to-left (in Arabic direction) produces a number that is divisible by 19:

$$43181911121719 = 19 \times 2272732164301$$

Although **19** and **2272732164301** are primes, they are not additive primes because their digit sums ($1+9=10$ and $2+2+7+2+7+3+2+1+6+4+3+0+1=40$.) are not primes.

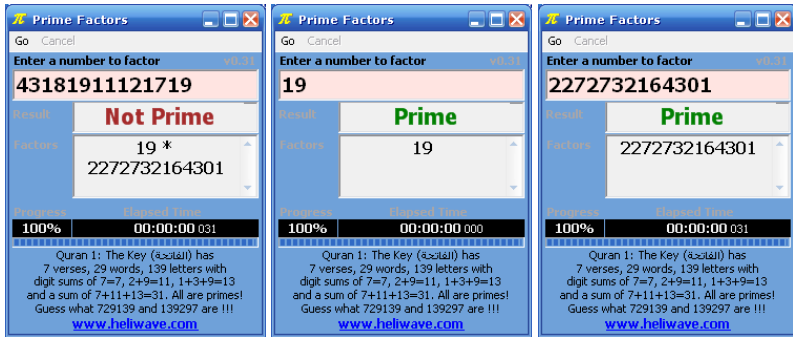

Prime Factorization of 43181911121719, 19 and 2272732164301

While this new prime number 2272732164301 seems mysterious, its digit sum of **40** may give a clue to its meaning.

40 is for Maturity

It takes **40 days** for the embryo to become matured and ready for Allah's **Spirit** to be breathed into it and to become a fetus, a new individual worthy of all human rights. Therefore, abortion is allowed prior to 40 days only in case of rape, etc. Then Allah gives the fetus *hearing, seeing and brain power*, in this sequence as per Quran 32:7 – 9:

أَعُوذُ بِاللَّهِ مِنَ الشَّيْطَانِ الرَّجِيمِ بِسْمِ اللَّهِ الرَّحْمَنِ الرَّحِيمِ

7. الَّذِي أَحْسَنَ كُلَّ شَيْءٍ خَلَقَهُ وَبَدَأَ خَلْقَ الْإِنْسَانِ مِنْ طِينٍ

He is the One who perfected everything He created, and started the creation of the human from clay.

8. ثُمَّ جَعَلَ نَسْلَهُ مِنْ سَلَالَةٍ مِّنْ مَّاءٍ مَّهِينٍ

Then He continued his reproduction through a certain lowly liquid.

9. ثُمَّ سَوَّاهُ وَنَفَخَ فِيهِ مِنْ رُّوحِهِ وَجَعَلَ لَكُمُ السَّمْعَ وَالْأَبْصَرَ وَالْأَفْئِدَةَ قَلِيلًا مَّا تَشْكُرُونَ

He shaped him and blew into him from His spirit. And He gave you the hearing, the eyesight, and the brains; rarely are you thankful.

It takes **40 weeks** for the fetus to mature into a ready-for-birth baby,
 $40 \times 7 = 280$ days \approx 9 lunar months 14 days \approx 9 solar months 5 days.

It takes **40 lunar months** for the baby's **long term memory** to become ready for the stage of knowledge accumulation. This is only a speculation and needs a proper verification by specialists in the field to be considered correct.

It takes **40 lunar years** for the human to have reached thinking maturity, **wisdom**, as per Quran 46:15:

أَعُوذُ بِاللَّهِ مِنَ الشَّيْطَانِ الرَّجِيمِ بِسْمِ اللَّهِ الرَّحْمَنِ الرَّحِيمِ

وَوَصَّيْنَا الْإِنْسَانَ بِوَالِدَيْهِ إِحْسَانًا حَمَلَتْهُ أُمُّهُ كُرْهًا وَوَضَعَتْهُ كُرْهًا وَحَمَلُهُ وَفِصْلُهُ ثَلَاثُونَ شَهْرًا حَتَّىٰ إِذَا بَلَغَ أَشُدَّهُ وَبَلَغَ أَرْبَعِينَ سَنَةً قَالَ رَبِّ أَوْزِعْنِي أَنْ أَشْكُرَ نِعْمَتَكَ الَّتِي أَنْعَمْتَ عَلَيَّ وَعَلَىٰ وَالِدَيَّ وَأَنْ أَعْمَلَ صَالِحًا تَرْضَاهُ وَأَصْلِحْ لِي فِي ذُرِّيَّتِي إِنِّي تُبْتُ إِلَيْكَ وَإِنِّي مِنَ الْمُسْلِمِينَ

We enjoined the human being to honor his parents. His mother bore him arduously, gave birth to him arduously, and carrying him (in the womb) and breastfeeding him for thirty months. Until he reaches maturity, and reaches age of forty (lunar years of hardship), he says, "My Lord, direct me to thank you for all the blessings You have bestowed upon me and upon my parents, and to do all the righteous deeds that please You, and direct my children (bloodline) to be righteous too. I have repented to You. I am a true submitter."

Extraterrestrial Life

So how do all these *forties* relate to our prime number 2272732164301 derived from concatenation the number of letter of the Key verses (19, 17, 12, 11, 19, 18, 43) right-to-left (in Arabic direction) that produced a composite that is only divisible by 19 and 2272732164301?

When you know that forty represents maturity and this number is somewhat large, then perhaps it is the number of days for **life in the Universe** to reach maturity:

$$2272732164301 \div 365.25 \approx 6,222,401,545 \approx 6.2 \text{ billion years}$$

Today's scientific estimation for the age of the Universe is about 13.6 billion years [http://en.wikipedia.org/wiki/Age_of_the_universe] but Allah the Creator and Sustainer of all Seen and Unseen worlds is the ultimate reference for all facts.

Wait a minute! Did I say "**life in the Universe**"? Yes! Thanks to an eye-opening video lecture by Abdul Daaem Al-Kaheel of www.kaheel7.com, Allah does confirm that there are other creatures living outside our Solar System spread afar in the Universe according to Quran 42:29:

أعوذ بالله من الشيطان الرجيم بِسْمِ اللَّهِ الرَّحْمَنِ الرَّحِيمِ

وَمِنْ آيَاتِهِ خَلْقُ السَّمَوَاتِ وَالْأَرْضِ وَمَا بَيْنَهُمَا مِنْ دَابَّةٍ وَهُوَ عَلَىٰ جَمْعِهِمْ إِذَا يَشَاءُ قَدِيرٌ

Among His proofs is the creation of the heavens and the earth, and the creatures He has spread in them. He is able to summon them, when He wills.

Seal of the Quran

And what about 19? Well if you know nothing about 19, then know this:

19 is the seal of the Quran as per Quran 74:30–31:

أَعُوذُ بِاللَّهِ مِنَ الشَّيْطَانِ الرَّجِيمِ بِسْمِ اللَّهِ الرَّحْمَنِ الرَّحِيمِ

“عَلَيْهَا تِسْعَةَ عَشَرَ”

“Over it (Hell) nineteen (angelic guards).”

وَمَا جَعَلْنَا أَصْحَابَ النَّارِ إِلَّا مَلَائِكَةً ۖ وَمَا جَعَلْنَا عِدَّتَهُمْ إِلَّا فِتْنَةً لِّلَّذِينَ كَفَرُوا ۗ لِيَسْتَيِّقَنَ الَّذِينَ أُوتُوا
الْكِتَابَ وَيَزِدَّادَ الَّذِينَ ءَامَنُوا إِيمَانًا ۖ وَلَا يَرْتَابَ الَّذِينَ أُوتُوا الْكِتَابَ وَالْمُؤْمِنُونَ ۚ وَلِيَقُولَ الَّذِينَ فِي
قُلُوبِهِم مَّرَضٌ وَالْكَافِرُونَ مَاذَا أَرَادَ اللَّهُ بِهَٰذَا مَثَلًا ۗ كَذٰلِكَ يُضِلُّ اللَّهُ مَن يَشَاءُ وَيَهْدِي مَن يَشَاءُ
وَمَا يَعْلَمُ جُنُودَ رَبِّكَ إِلَّا هُوَ ۗ وَمَا هِيَ إِلَّا ذِكْرَىٰ لِلنَّاسِ

“We appointed angels to be guardians of Hell, and we assigned their number (nineteen) (1) to test the disbelievers, (2) to convince the Christians and Jews (that this is a divine scripture), (3) to strengthen the faith of the faithful, (4) to remove all doubt from the hearts of Christians, Jews, and the believers, and (5) to expose those who harbor doubt in their hearts, and the disbelievers; they will say, "What did Allah mean by this allegory?" Allah thus sends astray whomever He wills, and guides whomever He wills. None knows the soldiers of your Lord except He. This is a reminder to all people.”

These five reasons state exactly why Allah has chosen the number 19 to be the seal of the Quran.

And just as 23 1s is an additive prime, 19 1s (1111111111111111111) is an additive prime too.

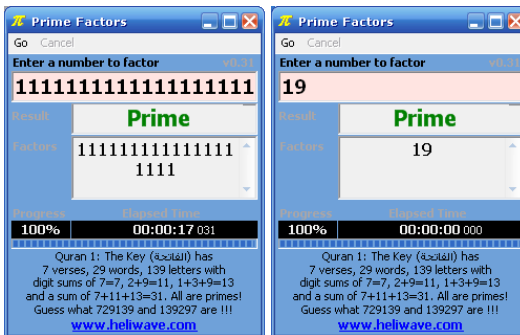

Prime Factorization of 1111111111111111111 and 19

Such primes with only 1s in their digits are called **Repunit Primes** [<http://gmplib.org/~tege/repunit.html>] and currently, the only known repunit primes have **2, 19, 23, 317, 1031, 49081, 86453, 109297, and 270343** 1s in them.

Note that all the numbers of 1s in these repunits are primes too and may continue to produce additive primes of 1s forever. 😊



Prime Factorization of 2, 19, 23, 317, 1031, 49081, 86453, 109297, and 270343

The Message

Having established that the structure of chapter The Key is firmly built upon prime numbers, attention was then turned to the structure of the whole Quran which consists of **114** chapters with various verse numbers as shown here:

7 + 286 + 200 + 176 + 120 + 165 + 206 + 75 + 129 + 109 + 123 + 111 + 43 + 52 + 99 + 128 + 111 + 110 + 98 + 135 + 112 + 78 + 118 + 64 + 77 + 227 + 93 + 88 + 69 + 60 + 34 + 30 + 73 + 54 + 45 + 83 + 182 + 88 + 75 + 85 + 54 + 53 + 89 + 59 + 37 + 35 + 38 + 29 + 18 + 45 + 60 + 49 + 62 + 55 + 78 + 96 + 29 + 22 + 24 + 13 + 14 + 11 + 11 + 18 + 12 + 12 + 30 + 52 + 52 + 44 + 28 + 28 + 20 + 56 + 40 + 31 + 50 + 40 + 46 + 42 + 29 + 19 + 36 + 25 + 22 + 17 + 19 + 26 + 30 + 20 + 15 + 21 + 11 + 8 + 8 + 19 + 5 + 8 + 8 + 11 + 11 + 8 + 3 + 9 + 5 + 4 + 7 + 3 + 6 + 3 + 5 + 4 + 5 + 6 = **6236** verses.

Although the number of chapters (**114**) and the total number of verses (**6236**) are not primes, verse Quran 15:87 gives a strong argument for considering the Quran as two parts:

أعوذ بالله من الشيطان الرجيم بسم الله الرحمن الرحيم

"وَلَقَدْ آتَيْنَاكَ سَبْعًا مِّنَ الْمَثَانِي وَالْقُرْآنَ الْعَظِيمَ"

"And We've given you seven of the doubles (or praise) and the great Quran."

The Prophet (peace be upon him and his disciples) explained the seven doubles are the seven verses of The Key chapter because the word "الْمَثَانِي" ("doubles") shares the same root with the word "تَنَاءٌ" ("praise") which is the main purpose of the whole chapter teaching man how to approach his Creator and Sustainer for guidance after praising and exalting Him.

Indeed once we have considered the Quran to be two parts: a **Key** part which consists only of The Key chapter and a **Message** part which consists of all the remaining 113 chapters, the 114 chapters and 6236 verses are split perfectly into additive primes numbers as follows:

Quran	=	Key	+	Message	
114	=	1	+	113	chapters
6236	=	7	+	6229	verses

All **113**, **7**, and **6229** are primes and their digit sums (1+1+3=5, 7=7, 6+2+2+9=19) are primes too. Additive primes indeed. **1** is the purest of prime and is truly indivisible and is therefore considered *The Unit*.

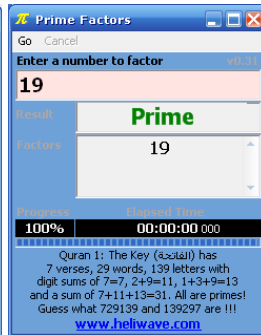
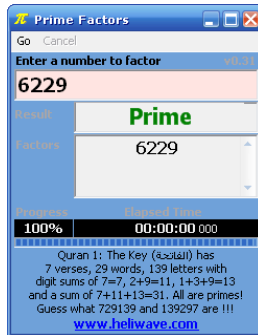
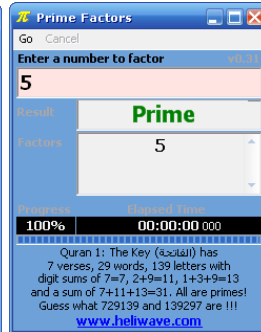
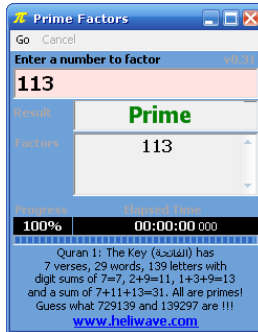
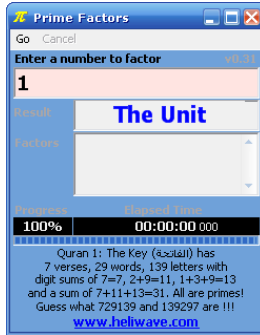

Prime Factorization of 1, 113, 5, 6229 and 19

This new two-part structure to the Quran suggests that the number of words and the number of letters for the whole Quran could also be additive primes, but confirmation of this must wait until a verified softcopy of the Quran becomes available.

Chapter Sequence Numbers

The Quran does not assign sequence numbers to chapters, but names only. Chapter sequence numbers have been added only recently to softcopies of the Quran and almost all hardcopies in use today do not have chapter numbers.

Therefore we are free to number the chapters in anyway that eases referencing, and based on the above equation **Quran = Key + Message**, a new 1+113 chapter numbering system is proposed where The Key remains as chapter #1 but all subsequent chapters of The Message are shifted back one place and thus get new numbers from #1 to #113 and we may do that for good reasons.

This new 1+113 chapter numbering system would give the chapter **Oneness of God** (الإخلاص) number #111 instead of #112 which is more in agreement with its name.

More importantly however, the new 1+113 chapter numbering system would put chapter #57 The Iron (الحديد) in its rightful place of #56 in agreement with the atomic mass of 56 of the most common type. That is 56 is ratio of the weight of most common type of Iron (isotope ${}_{26}^{56}\text{Fe}$) to the weight of the most common type of Hydrogen (isotope ${}_{1}^1\text{H}$).

While *atomic mass* is a relative measure of an element's weight to the weight of the lightest and most abundant element in the Universe, Hydrogen, *atomic number* is an absolute number that determines the kind of element an atom is and is the actual number of protons in the atom of that element.

Iron is element number 26 which means it has **26 protons**. But protons are positively charged particles and alone would repel each other without some sort of mediators in between. Such mediators are called **neutrons** and the most naturally occurring Iron isotope (${}_{26}^{56}\text{Fe}$) has **30** of them to ensure stability of its atom by keeping the protons glued within its nucleolus.

The following *Periodic Table of Elements* from Encyclopædia Britannica ©2009 [<http://cache.eb.com/eb/image?id=7445&rendTypeId=4>] lists all known elements by atomic numbers. It also arranges them vertically by groups (or families) and horizontally by periods. The main purpose of the Periodic Table is the ability to predict the chemical properties of an element based on its location (group and period) in the table.

Periodic table of the elements

group
1*
1s**

period
1
H
2
Li
Be
3
Na
Mg
4
K
Ca
Sc
Ti
V
Cr
Mn
Fe
Co
Ni
Cu
Zn
30
Ga
Ge
As
Se
Br
Kr
5
Rb
Sr
Y
Zr
Nb
Mo
Tc
Ru
Rh
Pd
Ag
Cd
In
Sn
Sb
Te
I
Xe
6
Cs
Ba
La
Hf
Ta
W
Re
Os
Ir
Pt
Au
Hg
Tl
Pb
Bi
Po
At
7
Fr
Ra
Ac
Rf
Db
Sg
Bh
Hs
Mt
Ds
Rg
(Uub)
(Uut)
(Uuq)
(Uup)
(Uuh)

18
0
He
Ne
Ar
Kr
Xe
Rn
(Uuo)

Legend:

- alkali metals
- alkaline earth metals
- transition metals
- other nonmetals
- other metalloids
- halogens
- noble gases
- rare earth elements (21, 39, 57-71)
- lanthanide elements (57-71 only)
- actinide elements

58	59	60	61	62	63	64	65	66	67	68	69	70	71
Ce	Pr	Nd	Pm	Sm	Eu	Gd	Tb	Dy	Ho	Er	Tm	Yb	Lu
90	91	92	93	94	95	96	97	98	99	100	101	102	103
Th	Pa	U	Np	Pu	Am	Cm	Bk	Cf	Es	Fm	Md	No	Lr

* Numbering system adopted by the International Union of Pure and Applied Chemistry (IUPAC).
 ** Numbering system widely used, especially in the U.S., from the mid-20th century.
 *** Discoveries of elements 112-116 and 118 are claimed but not confirmed. Element names and symbols in parentheses are temporarily assigned by IUPAC.

Periodic Table of the Elements
 (elements 112-116 and 118 are claimed but not confirmed)

New Atomic Model

But how do the neutrons mediate between the repelling protons? To answer the fundamental question, here is a short but accurate description with a new insight into the atomic world using the simple element of Helium (${}^2\text{He}$):

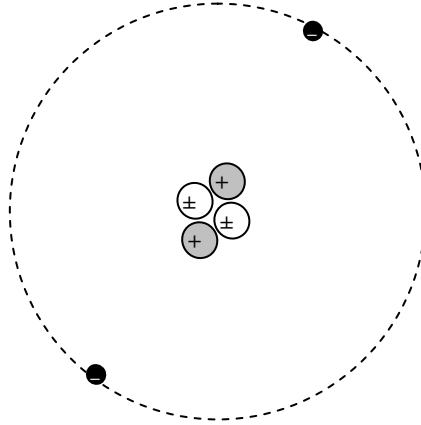

Helium Atom (${}^2\text{He}$ - isotope ${}^4\text{He}$)

At the center of the diagram there are four ball-shaped objects making up the nucleus of the Helium atom or element. This nucleus is spinning and its internal objects are oscillating all the time. While the two [+] objects represent the two protons that determine the kind of element as Helium, the other two [±] objects represent the two neutrons that prevent these two positively charged protons from flying away.

The neutrons continuously change their charge from positive to negative and vice versa to make the protons want to leave the nucleus when the neutrons are positive only for them to come back when the neutrons become negative. This continuous pulsation within the nucleus is the strong nuclear force that binds the nucleus together instead of what current science assume to be yet another particle in the particle zoon named *gluon* that mysteriously glues protons and neutrons together. [http://en.wikipedia.org/wiki/Force_carrier].

Outside the nucleus, there are God-ordained, prime number-related, prefixed energy levels that house electrons. The two [-] objects represent the two electrons needed for the Helium atom to stay neutral, or else it would become a positive ion if it loses electrons to other elements or a negative ion if it gains electrons from other elements.

The electrons continuously move along their circular orbits of the same energy level forming a spherical surface over time, known as *Shells*, or electron shells. These prefixed energy levels have been shown to have a direct relationship with the distribution of prime numbers as were already stated in the Prime Number History section discussed earlier

[<http://www.thefreelibrary.com/Quantum+physics+may+offer+clues+to+solving+prime+number+problem:...-a0186320999>]

Notice how the two negative electrons are precisely aligned with the two positive protons. This configuration makes both the nucleus and the electrons spin and circulate at the same angular velocity to maximize the rate of photon interchange between them called the *Electromagnetic Field*.

The reason electrons do not spiral down and crash into the positively charged nucleus is they orbit at such high speeds that the centrifugal force pushes them out to counteract the electrical attraction force pulling them in.

Atomic Number, Mass and Weight

The number of **protons** in an atom determines the kind of the element and is called the **Atomic Number** of the element. It is usually written as superscript before the element's symbol (e.g. ^1H , ^2He , ^3Li , ^4Be , ^5B , ^6C , ^7N , ^8O , ^9F , ^{10}Ne , ^{11}Na , ^{12}Mg , ^{13}Al , ..., ^{113}Uut).

On the other hand, the number of **neutrons** in an atom determines the type (or **isotope**) of the element and is usually written as subscript before the element's symbol (e.g. ^{12}C , ^{13}C , ^{14}C with the most abundant shown in bold).

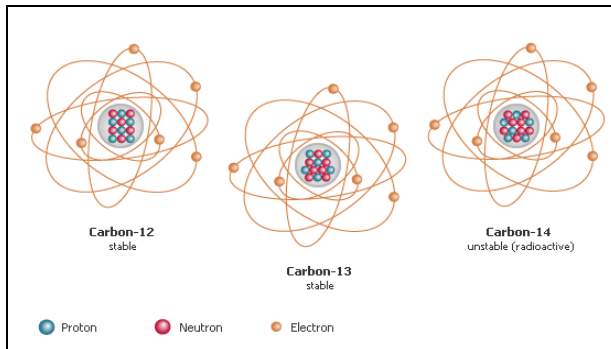

Isotopes of Carbon (stable 12 and 13 and radioactive 14)

The sum of the number of protons and neutrons of an isotope is called the **Atomic Mass** of that isotope and the average atomic mass of all the isotopes for that element, weighted by how abundant each isotope is, is called the **Atomic Weight** of the element as a whole
[http://en.wikipedia.org/wiki/Atomic_mass].

So for the element Iron (^{26}Fe) there exist four naturally occurring isotopes:

- ^{54}Fe with 5.85% abundance
- **^{56}Fe with 91.75% abundance**
- ^{57}Fe with 2.12% abundance and
- ^{58}Fe with only 0.28% abundance.

Source: [http://en.wikipedia.org/wiki/Isotopes_of_iron]

Abundance of Elements in the Quran

While the 1+113 chapter numbering system adjusts the sequence number of chapter The Iron (الحديد) to #**56** which becomes consistent with the atomic mass of the most abundant isotope of Iron, ^{56}Fe , the number of verses in each of the 113 chapters could actually give clues to the real abundance ratios of all 113 elements in the Universe (not just the solar system). This is an example of the indirect knowledge God has bestowed upon us but unfortunately Man chooses to stay blind to such holy knowledge.

Scientists claim to have identified 118 elements but cannot confirm the elements 112 – 116 and 118. See the *Period Table* above. All elements starting with “**uu**” have temporary names until they are stable enough to be considered as “natural” elements. In theory, one can have an infinite number of man-made elements by fusing existing elements at the nuclear level. However, the number of confirmed *natural* elements currently stands at 111 which is less than 113, the number of chapters of The Message.

The graphs below show the similarity between the scientifically accepted abundance of elements in our Solar System up to element 92 and the distribution of verses across all 113 chapters of The Message that hints at the abundance of elements in the Universe.

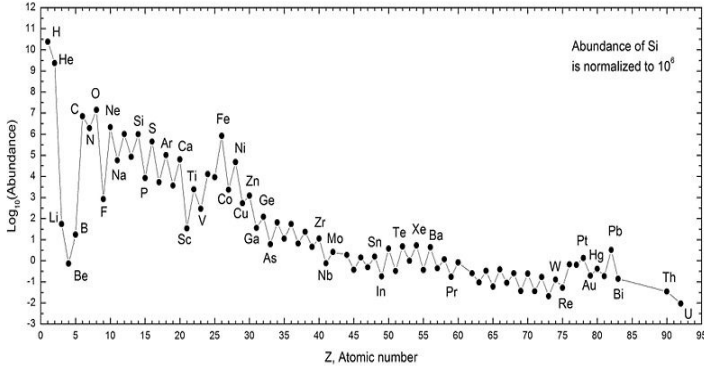

Abundance of Elements in the Solar System

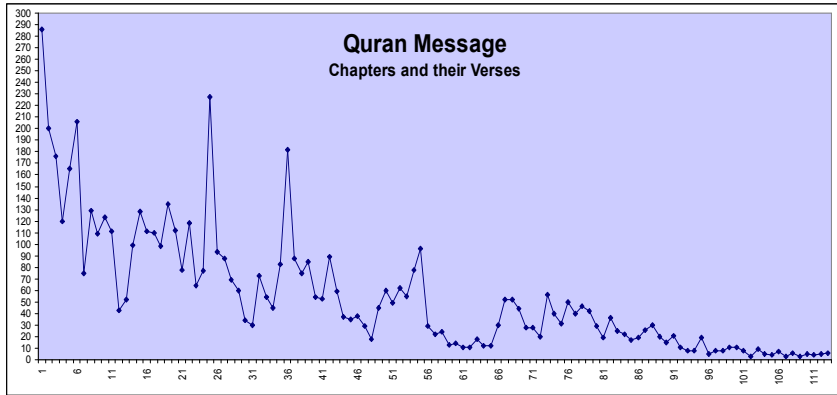

Verse counts of the 113 chapters of The Message

The abundance ratio of all 113 elements in the Universe (^1H , ^2He , ^3Li , ^4Be , ^5B , ^6C , ..., ^{113}Uut) [http://en.wikipedia.org/wiki/Abundance_of_the_chemical_elements] could therefore be directly inferred from the verse counts of the 113 chapters in The Message (^1Cow , $^2\text{Al-Umraan}$, $^3\text{Women}$, $^4\text{Feast}$, $^5\text{Livestock}$, ..., $^{113}\text{People}$).

If this theory is taken seriously then God knows what else can be extracted from the seemingly innocent numbers within the Holy Quran! Glory to Allah the Almighty, the All-knowing, the All-encompassing.

Numerology Systems

Having found that The Key and The Message parts of the Quran are firmly built upon prime numbers and in particular additive prime numbers, the possibility for unlocking hidden knowledge within The Message using *the key* found in The Key chapter was too great a challenge to miss.

Different numerology systems are in existence today for numerical studies of textual data. The *Abjad* system is the standard system used with Arabic text to calculate Gematrical Values of words or phrases. Perhaps, the Abjad system can show us a way forward to unlocking The Message of the Quran.

Abjad Numerology System

The Abjad numerology system [http://en.wikipedia.org/wiki/Abjad_numerals] assigns logarithmic values (1...10...100...1000) to the Arabic letters in the original Abjad order as shown here:

400	ت	60	س	8	ح	1	ا
500	ث	70	ع	9	ط	2	ب
600	خ	80	ف	10	ي	3	ج
700	ذ	90	ص	20	ك	4	د
800	ض	100	ق	30	ل	5	ه
900	ظ	200	ر	40	م	6	و
1000	غ	300	ش	50	ن	7	ز

Abjad Numerology System

In order to test the applicability of any numerology system we must first apply the system to The Key chapter and evaluate the results.

The Abjad Numerology System was applied to of the 139 letters of The Key chapter and produced **10143**, which may look a prime but is in fact a composite with a composite digit sum ($1+0+1+4+3 = 9$).

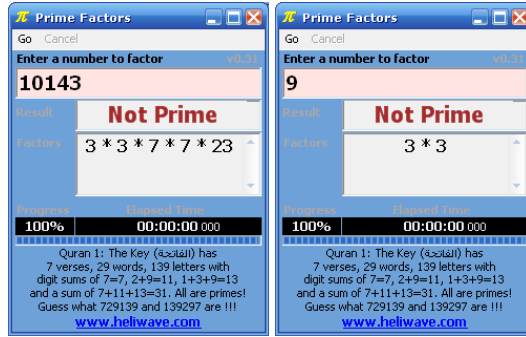

Prime Factorization of 10143 and 9

I expected a 4-digit prime to keep up with the linear increase in the number of digits of the prime numbers related to The Key chapter, not 5-digits:

7	verses	(1 digit)
29	words	(2 digits)
139	letters	(3 digits)
???	numerology value	(4 digits)

This numerology system was widely used in pre-Islam and may therefore not be appropriate to decoding the message of the Quran. Allah would surely want to make it harder to crack for future generations to discover a new system based on our current *Alphabetic* letter order not the old *Abjad* order, but Allah know best.

Further analysis confirmed that $10143 = 7^2 \times 207$ may mean (but only Allah knows all) that Allah the All-knowing was showing a positive result to those who used the *Abjad* system with an indirect hint at the *seven doubles* of Quran 15:87 with all these 7s and 2s., while preventing them from progressing any further by giving them the false impression that they have reached the limit.

أعوذ بالله من الشيطان الرجيم بِسْمِ اللَّهِ الرَّحْمَنِ الرَّحِيمِ

Quran 15:87 "وَلَقَدْ آتَيْنَاكَ سَبْعًا مِّنَ الْمَثَانِي وَالْقُرْآنَ الْعَظِيمَ"
 "And We've given you seven of the doubles (or praise) and the great Quran."

A newer post-Islamic system for the Holy Quran was therefore needed and Allah the All-knowing helped us greatly by making it plain to those who want to see the new system thinly hidden within the appropriately named chapter, *The Key*, a key to unlock the other 113 chapters, *The Message*.

Alphabet Primalogy System

One day while re-watching my favorite movie “CONTACT” (1997) [[http://en.wikipedia.org/wiki/Contact_\(film\)](http://en.wikipedia.org/wiki/Contact_(film))] written by the astronomer Carl Sagan (may God rest his soul in peace), Allah showed me something special, **The Way**. But before I explain what I was shown, here is a summary of the movie:

Dr Ellie Arroway is a scientist at the Arecibo Observatory in Puerto Rico for the Search for Extra-Terrestrial Intelligence (SETI) who listens to radio signals in the hope of finding intelligent life on other planetary systems.

Four years on, and with the government threatening to close the program, she finally receives a signal of a repeating sequence of prime numbers from 2 to 101 coming from Vega, a 26 light years away star near the center of our galaxy; the Milky Way.

*“But surely if such an advanced civilization exists, why wouldn't they simply use English to communicate with us?” The government argued. Ellie knowing her science very well answers “Mathematics is the only true universal language to communicate between difference civilizations and **prime numbers** are the best evidence of non-random intelligent”.*

While the government was busy announcing this great discovery to the world, Ellie and her team discovered a video signal buried deep within the original signal and soon uncovered a digital signal within the video signal in the form of thousands upon thousands of pages of data, digital data, but no one knows what to do with it.

Feeling at loss on how to decode this data, a helping hand came to her rescue and explained that the pages are to be interpreted in three dimensions and not in a paper-like two dimensions fashion and suddenly all make sense.

“Basic vocabularies for true and false, plus and minus, up and down, left and right, front, and back, before and after, ... were revealed and applying this newly found language to the rest of the message resulted in large volumes of schematic diagrams of a complex machine with a small pod for one human occupant to be dropped into three electromagnetically charged, rapidly spinning rings along X, Y, and Z axes” It was revealed.

It was a space-time travel machine that takes Ellie through a series of wormhole tunnels to Vega in an instance where she meets her father and then returned back without any evidence...

... or so they thought ☺

CONTACT (1997) Summary

So what was I shown? What was *The Way*?

Well, when the extraterrestrial message was received in the form of prime numbers from 2 to 101, the screen showed two rows filled with the prime numbers except for the last two slots at the bottom row as shown here:

2	3	5	7	11	13	17	19	23	29	31	37	41	43
47	53	59	61	67	71	73	79	83	89	97	101		

Prime Numbers in the movie CONTACT

I counted the number of prime numbers and they were 26 so asked myself “*What are the two empty slots for?*”; “*Why use 14 slots per row when 13 was enough?*” and almost immediately the reply came loud and clear.

Considering that the English language uses 26 letters, this immediately suggested that the filmmakers subliminally linked the 26 Latin alphabets [http://en.wikipedia.org/wiki/Latin_alphabet] to the first 26 prime numbers.

As such, the two empty slots were a big hint to any Arab person watching the movie to assign the first 28 prime numbers with the 28 letters of the Arabic alphabet [http://en.wikipedia.org/wiki/Arabic_alphabet] and fill the two empty slots with the next two primes in the series (**103** and **107**).

Therefore, all praise and thanks to Allah Almighty, a new numerology system named *Primalogy* was born that assigns **prime values** to **Arabic letters** in the modern Alphabetic order as shown here:

					1	ء	
79	ك	47	ض	19	د	2	ا
83	ل	53	ط	23	ذ	3	ب
89	م	59	ظ	29	ر	5	ت
97	ن	61	ع	31	ز	7	ث
101	ه	67	غ	37	س	11	ج
103	و	71	ف	41	ش	13	ح
107	ي	73	ق	43	ص	17	خ

Alphabet Primalogy System

Although the Arabic language has 28 letters, this research assumes that the standalone hamza (ء) is an independent letter that precedes all other letters and thus this new numerology system uses 29 letters, where 29 is also the number of words in The Key chapter. A coincidence perhaps! No chance. ☺

The standalone hamza (ء) is not part of chapter The Key and therefore does not affect our calculations, but as it precedes all other letters then it was decided to assign it the pure prime value 1. This assumption was shown to be correct when applied to the famous verse of chapter The Merciful.

Other semi-letters like the elf above letter (ا') and the floating hamza above line (اْ) are ignored while letters like the shortened elf (ي), the hamza above elf (ا') and hamza below elf (اِ) are all considered as basic elf and similarly hamza above waw (وْ) and above yaa (ياء) are considered as basic waw and yaa respectively. The knotted taa (ة) is considered a haa (ه).

PV of The Key Chapter

This newly born Primalogy system was applied to the 139 letters of chapter The Key (الفاتحة) as follows:

(1) م ي ح ر ل ا ن م ح ر ل ا ه ل ل ا م س ب
3+37+89 2+83+83+101 2+83+29+13+89+97 2+83+29+13+107+89

(2) ن ي م ل ع ل ا ب ر ه ل ل د م ح ل ا
2+83+13+89+19 83+83+101 29+3 2+83+61+83+89+107+97

(3) م ي ح ر ل ا ن م ح ر ل ا
2+83+29+13+89+97 2+83+29+13+107+89

(4) ن ي د ل ا م و ي ك ل م
89+83+79 107+103+89 2+83+19+107+97

(5) ن ي ع ت س ن ك ا ي ا و د ب ع ن ك ا ي ا
2+107+2+79 97+61+3+19 103+2+107+2+79 97+37+5+61+107+97

(6) م ي ق ت س م ل ا ط ر ص ل ا ن د ه ا
2+101+19+97+2 2+83+43+29+53 2+83+89+37+5+73+107+89

(7) م ه ي ل ع ت م ع ن ا ن ي ذ ل ا ط ر ص
43+29+53 2+83+23+107+97 2+97+61+89+5 61+83+107+101+89

م ه ي ل ع ب و ض غ م ل ا ر ي غ
67+107+29 2+83+89+67+47+103+3 61+83+107+101+89

ن ي ل ا ض ل ا ل و
103+83+2 2+83+47+2+83+107+97

Amazingly this produced a prime total primality value of **8317** with a prime digit sum of $8+3+1+7 = 19$ too, an additive prime number again.

If there was any doubt that this indeed is an unmistakable sign from God Almighty to use this new numerology system with the Arabic alphabet, then all doubts evaporated once I applied the proposed system to the 139 letters of The Key chapter and immediately got an additive prime *Primality Value* of **(8317 | 19)**. Thanks Allah for everything.

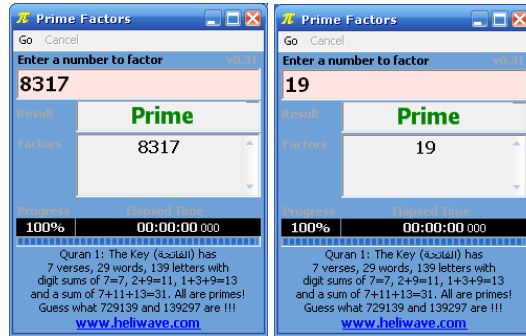

Prime Factorization of 8317 and 19

After discovering the additive prime 8317, it was a clear confirmation of the linear increase in digit numbers from 1 through 4 as follows:

7	verses	(1 digit)
29	words	(2 digits)
139	letters	(3 digits)
8317	primality value	(4 digits)

Indeed this is an extremely positive result that enforces the argument that the structure of The Key chapter is firmly built upon prime numbers with prime digit sums too, that is, additive primes and that “Bism Allah Ar-Rahmaan Ar-Raheem” is **mandatory** and must be recited with its chapter at all times.

PV of Oneness of God Chapter

In order to validate the new Primalogy system further, it was also applied to the Oneness of God (الإخلاص) chapter *with* and *without* the “Bism Allah Ar-Rahmaan Ar-Raheem” prefix.

Here is the complete chapter shown in the standard recitation method of Hafs (قراءة حفص) and the Uthmani style of writing (الرسم العثماني):

أعوذ بالله من الشيطان الرجيم بِسْمِ اللَّهِ الرَّحْمَنِ الرَّحِيمِ

<i>In the name of Allah, the Merciful, the Benevolent.</i>	بِسْمِ اللَّهِ الرَّحْمَنِ الرَّحِيمِ
<i>Say He is Allah, the One and Only.</i>	1. قُلْ هُوَ اللَّهُ أَحَدٌ
<i>Allah is Self-Sustainer, Self-Sufficient.</i>	2. اللَّهُ الصَّمَدُ
<i>Neither gives birth, nor was born.</i>	3. لَمْ يَلِدْ وَلَمْ يُولَدْ
<i>And nothing compares to Him.</i>	4. وَلَمْ يَكُن لَّهُ كُفُوًا أَحَدٌ

And here are the primalogy values for the letters in the chapter:

م ي ح ر ل ا ن م ح ر ل ا ه ل ل ا م س ب
 3+37+89 2+83+83+101 2+83+29+13+89+97 2+83+29+13+107+89

(1) د ح ا ه ل ل ا و ه ل ق
 73+83 101+103 2+83+83+101 2+13+19

(2) د م ص ل ا ه ل ل ا
 2+83+83+101 2+83+43+89+19

(3) د ل و ي م ل و د ل ي م ل
 83+89 107+83+19 103+83+89 107+103+83+19

(4) د ح ا ا و ف ك ه ل ن ك ي م ل و
 103+83+89 107+79+97 83+101 79+71+103+2 2+13+19

This too produced an additive prime total primalogy value of **4201** with a prime digit sum of $4+2+0+1 = 7$ *with* “Bism Allah Ar-Rahmaan Ar-Raheem”, and an additive prime total primalogy value of **3167** with a prime digit sum of $3+1+6+7 = 17$ *without* “Bism Allah Ar-Rahmaan Ar-Raheem”.

This clearly shows that the prefixed “Bism Allah Ar-Rahmaan Ar-Raheem” in the Oneness of God chapter is indeed a **prefix** (but not optional as some may think) and that is why it has no verse number.

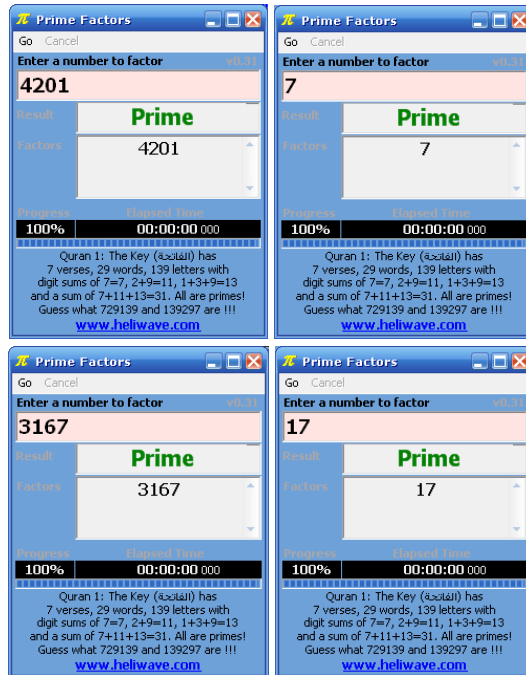

Prime Factorization of 4201, 7, 3167 and 17

This is yet another confirmation that this new Primalogy system is the correct numerology system to use with the Holy Text of the Quran.

Finally, counting the number of words and letters with and without the prefixed “Bism Allah Ar-Rahmaan Ar-Raheem” produced the following:

$$\begin{aligned}
 4+4+2+4+5 &= \mathbf{19} \text{ words} && \text{with bismAllah} \\
 19+11+9+12+15 &= \mathbf{66} \text{ letters} && \text{with bismAllah} \\
 4+2+4+5 &= \mathbf{15} \text{ words} && \text{without bismAllah} \\
 11+9+12+15 &= \mathbf{47} \text{ letters} && \text{without bismAllah}
 \end{aligned}$$

What lies behind these numbers, only God knows? Maybe we should take into account that this chapter represents one third of the Quran!

In any case, this chapter is not *The Key* chapter and as such there is no inconsistency to our additive prime numbers as the key to unlocking encoded messages within *The Message*. One day, God willing, when we find the reason(s) behind these numbers, we will say: “*Aha, now I know.*” ☺

PV of the Word Allah

Out of curiosity, the new Primology system was also applied to the word Allah (الله) as follows:

$$\text{ه ل ل ا} \\ 2+83+83+101$$

and the new Primology system produced a prime total primology value of **269** with a prime digit sum of $2+6+9 = 17$, an additive prime number indeed.

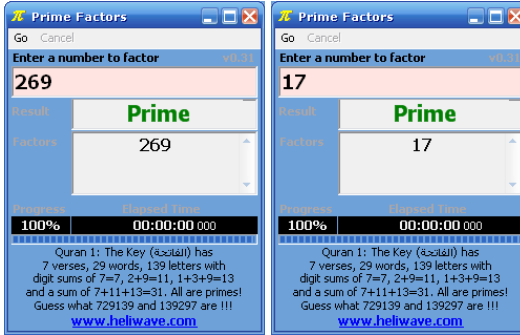

Prime Factorization of 269 and 17

Furthermore, I also found on the Internet that the word “Allah” (الله) including (فَالله, تَالله, لله, بالله) is repeated a prime number **2699** times in the Quran but cannot verify it. Although 2699 is a prime, it is not an additive prime as the sum of its digits is $2+6+9+9 = 26$. However, the curiosity of the numbers **26**, **269**, and **2699** is visually appealing.

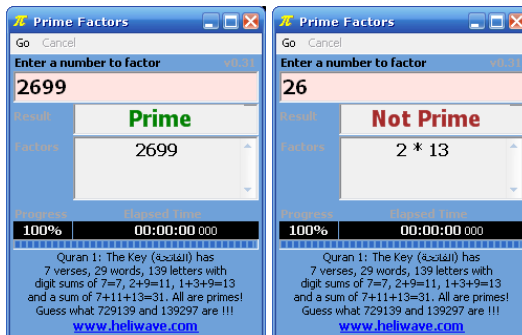

Prime Factorization of 2699 and 26

Other Primalogy Systems

Other primalogy systems under investigation assign additive prime numbers or additive prime number with only prime digits (pure primes) to the Arabic letters in different order systems (Abjad, alphabet, and in order of appearance in the Quran or in the text being studied e.g. chapter or verse).

For example, to use an additive primes with letters in **order of appearance** in the Quran, we first identify the first few additive primes (primes with prime digit sums) and then identify all the letters used in the Quran and arrange them in order of their appearance.

While the first few additive primes are easily identified, the number of the letters used in the Quran is debatable and one can opt to use either the 29 simple letters or all 37 letters with their variations.

Here is the list of the first 37 additive prime numbers:

2, 3, 5, 7, 11, 23, 29, 41, 43, 47, 61, 67, 83, 89, 101, 113, 131, 137, 139, 151, 157, 173, 179, 191, 193, 197, 199, 223, 227 , 229, 241, 263, 269, 281, 283 , 311, 313 .
--

In the above list the additive prime **277** is the 29th additive prime and is the largest prime number directly used in the Quran as the number of verses of *The Poets* (الشُّعْرَاء) chapter.

Similarly the 35th additive prime **283** is the largest prime number indirectly used in the Quran as a verse number in chapter #2 which consists of 286 verses in total. Indirectly because the original text of the Quran did not use verse numbers as verses separators but long spaces instead.

While the number **313** is the 37th additive prime and is very significant in Islam as it represents the number of Muslim soldiers in the first battle against evil, *The Battle of Bader*. It may also be the number of generals in the army of Imam Mehdi (may Allah bring forward his reappearance) who with the permission of Allah will rid Earth of the wide spread corruption and injustice and restore justice, peace, and love as was foretold by the Prophet (pbuh+f) as “*Three hundreds and several* (ثيَاف)”.

Here is the list of the 29 Arabic letters in order of appearance in the Quran assigned additive prime values:

					2	ب
179	ز	113	ص	43	ن	3
191	ء	131	ط	47	ي	5
193	خ	137	ق	61	د	7
197	ش	139	ذ	67	ع	11
199	ظ	151	غ	83	ك	23
223	ج	157	ض	89	و	29
227	ث	173	ف	101	ت	41

and here is the full list of all 37 Arabic letters and their variations in order of appearance in the Quran assigned pure prime values:

					2	ب
227	ة	151	ق	61	د	3
229	ز	157	ذ	67	ع	5
241	ء	173	أ	83	ك	7
263	خ	179	غ	89	و	11
269	ئ	191	ض	101	!	23
281	ش	193	آ	113	ا	29
283	ظ	197	ف	131	ت	41
311	ج	199	ى	137	ص	43
313	ث	223	و	139	ط	47

Thus far, the first and most simple system, *Alphabet Primology System*, produced the best results of additives primes consistently and may be the only system required to unlock some of the hidden knowledge of The Message of the Quran, God willing.

The Merciful Verse

The Merciful (الرحمن) chapter has a verse that repeats so many times that says:

أعوذ بالله من الشيطان الرجيم بسم الله الرحمن الرحيم

“فَيَأْتِيْءُ الْعَالَمِ رَبِّكُمْ تَكْدِبَانِ”

“What other bounties of your Sustainer do you still belie?”

Any inquisitive person should be curious as to how many repetitions there are. In fact there are **31** repetitions out of a total 78 verses.

The first thing one will notice is that 31 is the same *dangling* prime number found in chapter The Key, a prime number indeed but not an additive one.

The second thing to notice is that the number of the remaining verses of chapter The Merciful is $(78-31 = 47)$, that is a prime with a prime digit sum $(4+7=11)$ too, an additive prime once again. 😊

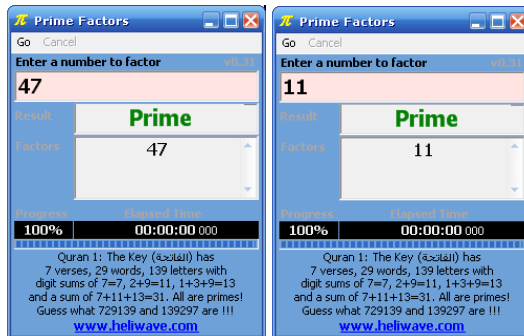

Prime Factorization of 47 and 11

Below is the complete chapter of The Merciful in Arabic with all 31 repetitions of the above verse highlighted:

The Merciful (الرحمن)

أعوذ بالله من الشيطان الرجيم بسم الله الرحمن الرحيم

بِسْمِ اللَّهِ الرَّحْمَنِ الرَّحِيمِ	
الرَّحْمَنُ	79.
عَلَّمَ الْقُرْآنَ	80.
خَلَقَ الْإِنْسَانَ	81.
عَلَّمَهُ الْبَيَانَ	82.
الشَّمْسُ وَالْقَمَرُ بِحُسْبَانٍ	83.
وَالنَّجْمُ وَالشَّجَرُ يَسْجُدَانِ	84.
وَالسَّمَاءَ رَفَعَهَا وَوَضَعَ الْمِيزَانَ	85.
أَلَّا تَطْغَوْا فِي الْمِيزَانِ	86.
وَأَقِيمُوا الْوَزْنَ بِالْقِسْطِ وَلَا تُخْسِرُوا الْمِيزَانَ	87.
وَالْأَرْضَ وَضَعَهَا لِلْأَنَامِ	88.
فِيهَا فَكِيهَةٌ وَالنَّجْلُ ذَاتُ الْأَكْمَامِ	89.
وَالْحَبُّ ذُو الْعَصْفِ وَالرَّيْحَانُ	90.
فَبِأَيِّ آلَاءِ رَبِّكُمَا تُكَذِّبَانِ	91.
خَلَقَ الْإِنْسَانَ مِنْ صَلْصَلٍ كَالْفَخَّارِ	92.
وَخَلَقَ الْجَانَّ مِنْ مَّارِجٍ مِّن نَّارٍ	93.
فَبِأَيِّ آلَاءِ رَبِّكُمَا تُكَذِّبَانِ	94.
رَبِّ الْمَشْرِقَيْنِ وَرَبِّ الْمَغْرِبَيْنِ	95.
فَبِأَيِّ آلَاءِ رَبِّكُمَا تُكَذِّبَانِ	96.
مَرَجَ الْبَحْرَيْنِ يَلْتَقِيَانِ	97.
بَيْنَهُمَا بَرْزَخٌ لَّا يَبْغِيَانِ	98.
فَبِأَيِّ آلَاءِ رَبِّكُمَا تُكَذِّبَانِ	99.
يَخْرُجُ مِنْهُمَا اللُّؤْلُؤُ وَالْمَرْجَانُ	100.
فَبِأَيِّ آلَاءِ رَبِّكُمَا تُكَذِّبَانِ	101.
وَلَهُ الْجَوَارِ الْمُنشَآتُ فِي الْبَحْرِ كَالْأَعْلَامِ	102.
فَبِأَيِّ آلَاءِ رَبِّكُمَا تُكَذِّبَانِ	103.
كُلٌّ مِّنْ عَلَيْهَا فَانٍ	104.
وَيَبْقَى وَجْهَ رَبِّكَ ذُو الْجَلَلِ وَالْإِكْرَامِ	105.
فَبِأَيِّ آلَاءِ رَبِّكُمَا تُكَذِّبَانِ	106.
يَسْأَلُهُ مَنْ فِي السَّمَوَاتِ وَالْأَرْضِ كُلَّ يَوْمٍ هُوَ فِي شَأْنٍ	107.
فَبِأَيِّ آلَاءِ رَبِّكُمَا تُكَذِّبَانِ	108.
سَنَفْرُغُ لَكُمْ أَيَّةَ الْقُلُوبِ	109.
فَبِأَيِّ آلَاءِ رَبِّكُمَا تُكَذِّبَانِ	110.
يَمْغِشُ الْجَنِّ وَالْإِنْسَ إِنْ أَسْتَعْثِمُوكُمْ إِنْ تَقَدَّوْا مِنْ أَقْطَارِ السَّمَوَاتِ وَالْأَرْضِ فَآتَقَدَّوْا ^٤ لَّا تَقْدُورُونَ إِيَّا سَيِّطُونَ	111.
فَبِأَيِّ آلَاءِ رَبِّكُمَا تُكَذِّبَانِ	112.
يُرْسَلُ عَلَيْكُمَا شَوَاظِمٌ مِّن نَّارٍ وَنَحَّاسٌ فَلَا تَنْتَصِرَانِ	113.
فَبِأَيِّ آلَاءِ رَبِّكُمَا تُكَذِّبَانِ	114.
فَإِذَا أَنْشَقَّتْ السَّمَاءُ فَكَانَتْ وَرْدَةً كَالدِّهَانِ	115.

116.	فَبِأَيِّ آلَاءِ رَبِّكُمَا تُكَذِّبَانِ
117.	فَيَوْمَئِذٍ لَّا يُسْئَلُ عَنْ ذَنْبِهِ إِنْسٌ وَلَا جَانٌّ
118.	فَبِأَيِّ آلَاءِ رَبِّكُمَا تُكَذِّبَانِ
119.	يُعْرِفُ الْمُجْرِمُونَ بِسِيمَاهُمْ فَيُؤْخَذُ بِالنَّوَصِي وَالْأَقْدَامِ
120.	فَبِأَيِّ آلَاءِ رَبِّكُمَا تُكَذِّبَانِ
121.	هَذِهِ جَهَنَّمُ الَّتِي يُكَذِّبُ بِهَا الْمُجْرِمُونَ
122.	يَطُوفُونَ بَيْنَهَا وَبَيْنَ حَمِيمٍ ءَانُ
123.	فَبِأَيِّ آلَاءِ رَبِّكُمَا تُكَذِّبَانِ
124.	وَلَمَنْ خَافَ مَقَامَ رَبِّهِ جِئْتَانِ
125.	فَبِأَيِّ آلَاءِ رَبِّكُمَا تُكَذِّبَانِ
126.	دَوَاتًا أَفْنَانُ
127.	فَبِأَيِّ آلَاءِ رَبِّكُمَا تُكَذِّبَانِ
128.	فِيهِمَا عَيْنَانِ تَجْرِيَانِ
129.	فَبِأَيِّ آلَاءِ رَبِّكُمَا تُكَذِّبَانِ
130.	فِيهِمَا مِنْ كُلِّ فِكْهَةٍ زَوْجَانِ
131.	فَبِأَيِّ آلَاءِ رَبِّكُمَا تُكَذِّبَانِ
132.	مُتَكِينِينَ عَلَىٰ فُرُشٍ بَطَازِنُهَا مِنْ إِسْتَبْرَقٍ ؕ وَجَنَىٰ الْجَنَّتَيْنِ دَانٌ
133.	فَبِأَيِّ آلَاءِ رَبِّكُمَا تُكَذِّبَانِ
134.	فِيهِنَّ قَصِيرَاتٌ الْفُرُشِ لَمْ يَطْمِئِنَّهُنَّ أَنَسٌ قَبْلَهُمْ وَلَا جَانٌّ
135.	فَبِأَيِّ آلَاءِ رَبِّكُمَا تُكَذِّبَانِ
136.	كَأَنَّهُنَّ الْيَاقُوتُ وَالْمَرْجَانُ
137.	فَبِأَيِّ آلَاءِ رَبِّكُمَا تُكَذِّبَانِ
138.	هَلْ جَزَاءُ الْإِحْسَانِ إِلَّا الْإِحْسَانُ
139.	فَبِأَيِّ آلَاءِ رَبِّكُمَا تُكَذِّبَانِ
140.	وَمِنْ ذُنُوبِهِمَا جِنَّتَانِ
141.	فَبِأَيِّ آلَاءِ رَبِّكُمَا تُكَذِّبَانِ
142.	مُدْهَامَتَانِ
143.	فَبِأَيِّ آلَاءِ رَبِّكُمَا تُكَذِّبَانِ
144.	فِيهِمَا عَيْنَانِ نَضَّخَتَا
145.	فَبِأَيِّ آلَاءِ رَبِّكُمَا تُكَذِّبَانِ
146.	فِيهِمَا فِكْهَةٌ وَنَخْلٌ وَرِمَازٌ
147.	فَبِأَيِّ آلَاءِ رَبِّكُمَا تُكَذِّبَانِ
148.	فِيهِنَّ خَيْرَاتٌ حِسَانٌ
149.	فَبِأَيِّ آلَاءِ رَبِّكُمَا تُكَذِّبَانِ
150.	حُورٌ مَّقْصُورَاتٌ فِي الْخِيَامِ
151.	فَبِأَيِّ آلَاءِ رَبِّكُمَا تُكَذِّبَانِ
152.	لَمْ يَطْمِئِنَّهُنَّ أَنَسٌ قَبْلَهُمْ وَلَا جَانٌّ
153.	فَبِأَيِّ آلَاءِ رَبِّكُمَا تُكَذِّبَانِ
154.	مُتَكِينِينَ عَلَىٰ رُفُوفٍ خَضْرَاءَ وَعَبَقْرَىٰ حِسَانٌ
155.	فَبِأَيِّ آلَاءِ رَبِّكُمَا تُكَذِّبَانِ
156.	تَبَارَكَ اسْمُ رَبِّكَ ذِي الْجَلَالِ وَالْإِكْرَامِ

And here one English translation taken from [<http://www.al-islam.org/quran/>]

In the name of Allah, the Merciful, the Benevolent:

In the name of Allah, the Merciful, the Benevolent

[1] *The Beneficent Allah,*

[2] *Taught the Quran.*

[3] *He created man,*

[4] *Taught him the mode of expression.*

[5] *The sun and the moon follow a reckoning.*

[6] *And the herbs and the trees do prostrate (to Him).*

[7] *And the heaven, He raised it high, and He made the balance*

[8] *That you may not be inordinate in respect of the measure.*

[9] *And keep up the balance with equity and do not make the measure deficient.*

[10] *And the earth, He has set it for living creatures;*

[11] *Therein is fruit and palms having sheathed clusters,*

[12] *And the grain with (its) husk and fragrance.*

[13] *Which then of the bounties of your Lord will you (both man and jinn) deny?*

[14] *He created man from dry clay like earthen vessels,*

[15] *And He created the jinn of a flame of fire.*

[16] *Which then of the bounties of your Lord will you (both man and jinn) deny?*

[17] *Lord of the East and Lord of the West.*

[18] *Which then of the bounties of your Lord will you (both man and jinn) deny?*

[19] *He has made the two seas to flow freely (so that) they meet together:*

[20] *Between them is a barrier which they cannot pass.*

[21] *Which then of the bounties of your Lord will you (both man and jinn) deny?*

[22] *There come forth from them pearls, both large and small.*

[23] *Which then of the bounties of your Lord will you (both man and jinn) deny?*

[24] *And His are the ships reared aloft in the sea like mountains.*

[25] *Which then of the bounties of your Lord will you (both man and jinn) deny?*

[26] *Everyone on it must pass away.*

[27] *And there will endure for ever the person of your Lord, the Lord of glory and honor.*

[28] *Which then of the bounties of your Lord will you (both man and jinn) deny?*

[29] *All those who are in the heavens and the earth ask of Him; every moment He is in a state (of glory).*

[30] *Which then of the bounties of your Lord will you (both man and jinn) deny?*

[31] *Soon will We apply Ourselves to you, O you two armies.*

[32] *Which then of the bounties of your Lord will you (both man and jinn) deny?*

[33] *O assembly of the jinn and the men! If you are able to pass through the regions of the heavens and the earth, then pass through; you cannot pass through but with authority*

[34] *Which then of the bounties of your Lord will you (both man and jinn) deny?*

[35] *The flames of fire and smoke will be sent on you two, then you will not be able to defend yourselves.*

[36] *Which then of the bounties of your Lord will you (both man and jinn) deny?*

[37] *And when the heaven is rent asunder, and then becomes red like red hide.*

- [38] Which then of the bounties of your Lord will you (both man and jinn) deny?
[39] So on that day neither man nor jinni shall be asked about his sin.
[40] Which then of the bounties of your Lord will you (both man and jinn) deny?
[41] The guilty shall be recognized by their marks, so they shall be seized by the forelocks and the feet.
[42] Which then of the bounties of your Lord will you (both man and jinn) deny?
[43] This is the hell which the guilty called a lie.
[44] Round about shall they go between it and hot, boiling water.
[45] Which then of the bounties of your Lord will you (both man and jinn) deny?
[46] And for him who fears to stand before his Lord are two gardens.
[47] Which then of the bounties of your Lord will you (both man and jinn) deny?
[48] Having in them various kinds.
[49] Which then of the bounties of your Lord will you (both man and jinn) deny?
[50] In both of them are two fountains flowing.
[51] Which then of the bounties of your Lord will you (both man and jinn) deny?
[52] In both of them are two pairs of every fruit.
[53] Which then of the bounties of your Lord will you (both man and jinn) deny?
[54] Reclining on beds, the inner coverings of which are of silk brocade; and the fruits of the two gardens shall be within reach.
[55] Which then of the bounties of your Lord will you (both man and jinn) deny?
[56] In them shall be those who restrained their eyes; before them neither man nor jinni shall have touched them.
[57] Which then of the bounties of your Lord will you (both man and jinn) deny?
[58] As though they were rubies and pearls.
[59] Which then of the bounties of your Lord will you (both man and jinn) deny?
[60] Is the reward of goodness aught but goodness?
[61] Which then of the bounties of your Lord will you (both man and jinn) deny?
[62] And besides these two are two (other) gardens:
[63] Which then of the bounties of your Lord will you (both man and jinn) deny?
[64] Both inclining to blackness.
[65] Which then of the bounties of your Lord will you (both man and jinn) deny?
[66] In both of them are two springs gushing forth.
[67] Which then of the bounties of your Lord will you (both man and jinn) deny?
[68] In both are fruits and palms and pomegranates.
[69] Which then of the bounties of your Lord will you (both man and jinn) deny?
[70] In them are goodly things, beautiful ones.
[71] Which then of the bounties of your Lord will you (both man and jinn) deny?
[72] Pure ones confined to the pavilions.
[73] Which then of the bounties of your Lord will you (both man and jinn) deny?
[74] Man has not touched them before them nor jinni.
[75] Which then of the bounties of your Lord will you (both man and jinn) deny?
[76] Reclining on green cushions and beautiful carpets.
[77] Which then of the bounties of your Lord will you (both man and jinn) deny?
[78] Blessed be the name of your Lord, the Lord of Glory and Honor!

The Merciful Chapter with the Merciful Verse Highlighted – (Translation)

PV of the Merciful Verse

Using the new Primalogy system the total primalogy value for The Merciful verse (قَبَائِيَّ ءَالَاءِ رَبِّكُمَا تُكَذِّبَانِ) was calculated and amazing was found to be an additive prime once again when assigning 1 to the standalone hamza and simplifying the **ى** to **ي** as was proposed earlier. Here is the calculation:

ن ا ب ذ ك ت ا م ك ب ر ء ا ل ا ء ي ا ب ف

$$71+3+2+107 + 1+2+83+2+1 + 29+3+79+89+2 + 5+79+23+3+2+97 = 683$$

which is a prime and with a prime digit sum of $6+8+3 = 17$ too. ☺

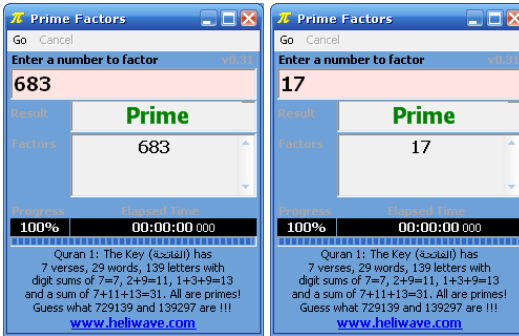

Prime Factorization of 683 and 17

Merciful Verse Numbers

What are the repeated verse numbers pointing to?

Here are the numbers:

**13, 16, 18, 21, 23, 25, 28, 30, 32, 34, 36, 38, 40, 42, 45,
47, 49, 51, 53, 55, 57, 59, 61, 63, 65, 67, 69, 71, 73, 75, 77**

I tried to interpret them as pointers to letters in The Key chapter, words in The Merciful chapter, and even verses or chapters in the Holy Quran but to no avail. No positive results were found thus far.

I decided to do the obvious and sum them up and this was exactly what unraveled one of the great mysteries behind the Merciful verse. Another equally great mystery was found by concatenating them right to left (Arabic direction) as will be seen shortly.

Adding up the Merciful verse numbers produced a prime number as follows:

$$13+16+18+21+23+25+28+30+32+34+36+38+40+42+45+47+49+51+53+55+57+59+61+63+65+67+69+71+73+75+77 = 1433.$$

And once again the digit sum ($1+4+3+3 = 11$) was prime number, making it an additive prime number, clear evidence that we are on the right path. ☺

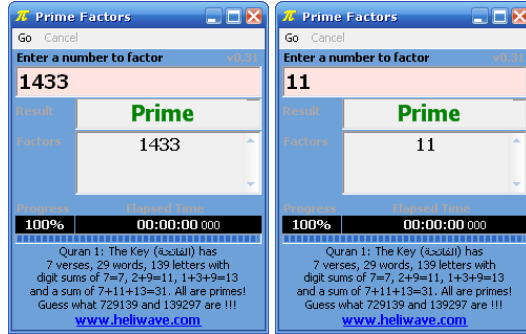

Prime Factorization of 1433 and 11

Now I am absolutely convinced of two things:

1. If a piece of Quranic text has a Primology Value that is an additive prime number (a prime number with a prime digit sum) then it means we have reached the end of the numerical analysis for this piece and we better start using this new finding as a key for another part of the big puzzle.
2. If a valid mathematical operation results in an additive prime then the result is also a key for another part of the big puzzle. By valid mathematical operation I mean adding, multiplying, concatenation, etc. of likes with likes only, letters with letters, words with words, verses with verses, or chapters with chapter but not mix and match to achieve desired targets haphazardly. Full rules can be found in the section [Research Methodology](#).

So, where do the numbers **683** (PV of the Merciful verse) and **1433** (the sum of the verse numbers of the Merciful verse) point to? While the number **683** served to confirm the standalone hamza (ء) position before the elf (ل) and therefore was assigned a PV value of 1, the purpose of the number **1433** is not obvious if you are not a Muslim or live in a non-Muslim country.

Quran and 2012

Exactly four days passed full of excitement thinking of my next move before it struck me. The current Hijri year is **1429AH** and 1433 could well be a reference to the Hijri year **1433AH** which maps to the year **2012AD**.

Immediately, all fell into place; I was full of excitement and joy for having received a real communication from the Lord. I was 100% sure the number 1433 is a pointer the year **1433AH** (After Hijra or after the Prophet migration from Makkah to Medina) which will be **2012AD** (Anno Domini).

All hell broke loose on me when I told others of this fact. Many It was a bittersweet experience. On one hand I had something so real that you can only fully appreciate it if you know how special prime numbers are let alone additive prime numbers. On the other hand, close friends suggested that I should seek medical help or see a psychiatrist. They accused me of deluding myself with numbers that mean nothing more than their face values. I was insulted with following astrology and numerology, knowing the mind of God, seeing into the future, deviating from the meaning of the Quranic text and playing randomly with numbers, to name but a few. I started losing friends left, right, and centre.

“Thanks God for everything” I always say, even for being God forbid, condemned to Hell for with constant supplications and with God’s limitless mercy qualitatively (أَلرَّحْمٰنُ) and quantitatively (أَلرَّحِيْمُ) one would hope to be forgiven and saved from his ever-desiring self (النفس الأُمارة بالسوء).

Needless to say, I resigned from work and left the UAE and moved to China where people are more objective and indeed supportive knowing that Allah never forgets His sincere servants (if I am allowed to say that) and indeed within few weeks and on a flight back to the UAE, He gave me the much needed proof from an African man from Mali. **Glory to Allah Almighty, the real-time Sustainer of the Seen and Unseen worlds.**

Although the man spoke little English (as his native language was French), we were able to communicate a bit. At some stage during the flight, I found that he is Muslim and can read some Quran albeit with little understanding. I get encouraged by that and asked him to count how many repetitions of the Merciful verse there are on my Pocket Quran? He misunderstood me and started counting words instead so I politely corrected him and he counted 31 repetitions at which point I told him about the sum of their numbers and its relationship to the Hijri year 1433AH and end of story.

But as everybody was trying to get some sleep and in the midst of few minutes of calmness, I felt that God had just shown me the man counting words for a reason as nothing happens by chance. I feverishly started counting the words myself and the nearer I got to the end the more I felt I am closing on 365 which would definitely prove we are dealing with a year but I was disappointed. I only counted **355 words** even with the prefix Bism Allah Ar-Rahmaan Ar-Raheem. So I recounted, and once again it was the same result, 355 words!

A few seconds later my face was glowing full of smile and with the Light of Allah when I remembered that a lunar year is about 11 days shorter than a solar one. I feverishly launched my Hijri Calendar on my PocketPC and God behold! there are exactly **355 days** in the Hijri year **1433AH** as listed here as days per month:

$$30+29+30+30+29+30+30+29+30+29+30+29 = 355 \text{ days.}$$

[http://www.islamicfinder.org/Hcal/hdate_year.php?year=1433&base=h]

No one can imagine the tears of joy I had high up at 11km altitude. It was a truly heavenly experience. I sincerely thanked Allah for giving me the proof that the number **1433** (the sum of the numbers of the repeated Merciful verse) is indeed a pointer to the Hijri year **1433AH**.

Event Dates

The fact that the number of words in the chapter equals to the number of days in the year 1433AH not only confirms that the prime number 1433 is in fact a reference to the year 1433AH but incredibly revealing that:

Every word in The Merciful chapter maps to a day in the year 1433AH.

Below is the calendar for the year 1433AH with the days mapped to the words of the Merciful verse highlighted. All days have ± 1 day error margin and start at sunset the previous day with Makkah's sunset horizon as the Islamic Date Line* for that day, as well as a table showing that the first Merciful verse starts at word 44 or the 44th day of 1433AH (sunset of **07 January 2012**), while the last Merciful verse ends at word 349 or the 349th day of 1433AH (sunset of **07 November 2012**).

* The Islamic Date Line concept is proposed by Ali Adams to unite the Hijri calendar for the whole Earth. For full details, please read the Islamic Date Line section under Further Thoughts at the end of the book.

<p style="text-align: center;">MuHarram 1433 Nov - Dec 2011</p> <table border="1"> <thead> <tr><th>S</th><th>S</th><th>M</th><th>T</th><th>W</th><th>T</th><th>F</th></tr> </thead> <tbody> <tr><td>1</td><td>2</td><td>3</td><td>4</td><td>5</td><td>6</td><td>7</td></tr> <tr><td>26</td><td>27</td><td>28</td><td>29</td><td>30</td><td>1</td><td>2</td></tr> <tr><td>8</td><td>9</td><td>10</td><td>11</td><td>12</td><td>13</td><td>14</td></tr> <tr><td>3</td><td>4</td><td>5</td><td>6</td><td>7</td><td>8</td><td>9</td></tr> <tr><td>15</td><td>16</td><td>17</td><td>18</td><td>19</td><td>20</td><td>21</td></tr> <tr><td>10</td><td>11</td><td>12</td><td>13</td><td>14</td><td>15</td><td>16</td></tr> <tr><td>22</td><td>23</td><td>24</td><td>25</td><td>26</td><td>27</td><td>28</td></tr> <tr><td>17</td><td>18</td><td>19</td><td>20</td><td>21</td><td>22</td><td>23</td></tr> <tr><td>29</td><td>30</td><td></td><td></td><td></td><td></td><td></td></tr> <tr><td>24</td><td>25</td><td></td><td></td><td></td><td></td><td></td></tr> </tbody> </table>	S	S	M	T	W	T	F	1	2	3	4	5	6	7	26	27	28	29	30	1	2	8	9	10	11	12	13	14	3	4	5	6	7	8	9	15	16	17	18	19	20	21	10	11	12	13	14	15	16	22	23	24	25	26	27	28	17	18	19	20	21	22	23	29	30						24	25						<p style="text-align: center;">Safar 1433 Dec 2011 - Jan 2012</p> <table border="1"> <thead> <tr><th>S</th><th>S</th><th>M</th><th>T</th><th>W</th><th>T</th><th>F</th></tr> </thead> <tbody> <tr><td></td><td></td><td>1</td><td>2</td><td>3</td><td>4</td><td>5</td></tr> <tr><td></td><td></td><td>26</td><td>27</td><td>28</td><td>29</td><td>30</td></tr> <tr><td>6</td><td>7</td><td>8</td><td>9</td><td>10</td><td>11</td><td>12</td></tr> <tr><td>31</td><td>1</td><td>2</td><td>3</td><td>4</td><td>5</td><td>6</td></tr> <tr><td>13</td><td>14</td><td>15</td><td>16</td><td>17</td><td>18</td><td>19</td></tr> <tr><td>7</td><td>8</td><td>9</td><td>10</td><td>11</td><td>12</td><td>13</td></tr> <tr><td>20</td><td>21</td><td>22</td><td>23</td><td>24</td><td>25</td><td>26</td></tr> <tr><td>14</td><td>15</td><td>16</td><td>17</td><td>18</td><td>19</td><td>20</td></tr> <tr><td>27</td><td>28</td><td>29</td><td></td><td></td><td></td><td></td></tr> <tr><td>21</td><td>22</td><td>23</td><td></td><td></td><td></td><td></td></tr> </tbody> </table>	S	S	M	T	W	T	F			1	2	3	4	5			26	27	28	29	30	6	7	8	9	10	11	12	31	1	2	3	4	5	6	13	14	15	16	17	18	19	7	8	9	10	11	12	13	20	21	22	23	24	25	26	14	15	16	17	18	19	20	27	28	29					21	22	23					<p style="text-align: center;">Rabec' I 1433 Jan - Feb 2012</p> <table border="1"> <thead> <tr><th>S</th><th>S</th><th>M</th><th>T</th><th>W</th><th>T</th><th>F</th></tr> </thead> <tbody> <tr><td></td><td></td><td></td><td>1</td><td>2</td><td>3</td><td>4</td></tr> <tr><td></td><td></td><td></td><td>24</td><td>25</td><td>26</td><td>27</td></tr> <tr><td>5</td><td>6</td><td>7</td><td>8</td><td>9</td><td>10</td><td>11</td></tr> <tr><td>28</td><td>29</td><td>30</td><td>31</td><td>1</td><td>2</td><td>3</td></tr> <tr><td>12</td><td>13</td><td>14</td><td>15</td><td>16</td><td>17</td><td>18</td></tr> <tr><td>4</td><td>5</td><td>6</td><td>7</td><td>8</td><td>9</td><td>10</td></tr> <tr><td>19</td><td>20</td><td>21</td><td>22</td><td>23</td><td>24</td><td>25</td></tr> <tr><td>11</td><td>12</td><td>13</td><td>14</td><td>15</td><td>16</td><td>17</td></tr> <tr><td>26</td><td>27</td><td>28</td><td>29</td><td>30</td><td></td><td></td></tr> <tr><td>18</td><td>19</td><td>20</td><td>21</td><td>22</td><td></td><td></td></tr> </tbody> </table>	S	S	M	T	W	T	F				1	2	3	4				24	25	26	27	5	6	7	8	9	10	11	28	29	30	31	1	2	3	12	13	14	15	16	17	18	4	5	6	7	8	9	10	19	20	21	22	23	24	25	11	12	13	14	15	16	17	26	27	28	29	30			18	19	20	21	22																
S	S	M	T	W	T	F																																																																																																																																																																																																																																																	
1	2	3	4	5	6	7																																																																																																																																																																																																																																																	
26	27	28	29	30	1	2																																																																																																																																																																																																																																																	
8	9	10	11	12	13	14																																																																																																																																																																																																																																																	
3	4	5	6	7	8	9																																																																																																																																																																																																																																																	
15	16	17	18	19	20	21																																																																																																																																																																																																																																																	
10	11	12	13	14	15	16																																																																																																																																																																																																																																																	
22	23	24	25	26	27	28																																																																																																																																																																																																																																																	
17	18	19	20	21	22	23																																																																																																																																																																																																																																																	
29	30																																																																																																																																																																																																																																																						
24	25																																																																																																																																																																																																																																																						
S	S	M	T	W	T	F																																																																																																																																																																																																																																																	
		1	2	3	4	5																																																																																																																																																																																																																																																	
		26	27	28	29	30																																																																																																																																																																																																																																																	
6	7	8	9	10	11	12																																																																																																																																																																																																																																																	
31	1	2	3	4	5	6																																																																																																																																																																																																																																																	
13	14	15	16	17	18	19																																																																																																																																																																																																																																																	
7	8	9	10	11	12	13																																																																																																																																																																																																																																																	
20	21	22	23	24	25	26																																																																																																																																																																																																																																																	
14	15	16	17	18	19	20																																																																																																																																																																																																																																																	
27	28	29																																																																																																																																																																																																																																																					
21	22	23																																																																																																																																																																																																																																																					
S	S	M	T	W	T	F																																																																																																																																																																																																																																																	
			1	2	3	4																																																																																																																																																																																																																																																	
			24	25	26	27																																																																																																																																																																																																																																																	
5	6	7	8	9	10	11																																																																																																																																																																																																																																																	
28	29	30	31	1	2	3																																																																																																																																																																																																																																																	
12	13	14	15	16	17	18																																																																																																																																																																																																																																																	
4	5	6	7	8	9	10																																																																																																																																																																																																																																																	
19	20	21	22	23	24	25																																																																																																																																																																																																																																																	
11	12	13	14	15	16	17																																																																																																																																																																																																																																																	
26	27	28	29	30																																																																																																																																																																																																																																																			
18	19	20	21	22																																																																																																																																																																																																																																																			
<p style="text-align: center;">Rabec' II 1433 Feb - Mar 2012</p> <table border="1"> <thead> <tr><th>S</th><th>S</th><th>M</th><th>T</th><th>W</th><th>T</th><th>F</th></tr> </thead> <tbody> <tr><td></td><td></td><td></td><td></td><td></td><td>1</td><td>2</td></tr> <tr><td></td><td></td><td></td><td></td><td></td><td>23</td><td>24</td></tr> <tr><td>3</td><td>4</td><td>5</td><td>6</td><td>7</td><td>8</td><td>9</td></tr> <tr><td>25</td><td>26</td><td>27</td><td>28</td><td>29</td><td>1</td><td>2</td></tr> <tr><td>10</td><td>11</td><td>12</td><td>13</td><td>14</td><td>15</td><td>16</td></tr> <tr><td>3</td><td>4</td><td>5</td><td>6</td><td>7</td><td>8</td><td>9</td></tr> <tr><td>17</td><td>18</td><td>19</td><td>20</td><td>21</td><td>22</td><td>23</td></tr> <tr><td>10</td><td>11</td><td>12</td><td>13</td><td>14</td><td>15</td><td>16</td></tr> <tr><td>24</td><td>25</td><td>26</td><td>27</td><td>28</td><td>29</td><td>30</td></tr> <tr><td>17</td><td>18</td><td>19</td><td>20</td><td>21</td><td>22</td><td>23</td></tr> </tbody> </table>	S	S	M	T	W	T	F						1	2						23	24	3	4	5	6	7	8	9	25	26	27	28	29	1	2	10	11	12	13	14	15	16	3	4	5	6	7	8	9	17	18	19	20	21	22	23	10	11	12	13	14	15	16	24	25	26	27	28	29	30	17	18	19	20	21	22	23	<p style="text-align: center;">Jumaadi I 1433 Mar - Apr 2012</p> <table border="1"> <thead> <tr><th>S</th><th>S</th><th>M</th><th>T</th><th>W</th><th>T</th><th>F</th></tr> </thead> <tbody> <tr><td>1</td><td>2</td><td>3</td><td>4</td><td>5</td><td>6</td><td>7</td></tr> <tr><td>24</td><td>25</td><td>26</td><td>27</td><td>28</td><td>29</td><td>30</td></tr> <tr><td>8</td><td>9</td><td>10</td><td>11</td><td>12</td><td>13</td><td>14</td></tr> <tr><td>31</td><td>1</td><td>2</td><td>3</td><td>4</td><td>5</td><td>6</td></tr> <tr><td>15</td><td>16</td><td>17</td><td>18</td><td>19</td><td>20</td><td>21</td></tr> <tr><td>7</td><td>8</td><td>9</td><td>10</td><td>11</td><td>12</td><td>13</td></tr> <tr><td>22</td><td>23</td><td>24</td><td>25</td><td>26</td><td>27</td><td>28</td></tr> <tr><td>14</td><td>15</td><td>16</td><td>17</td><td>18</td><td>19</td><td>20</td></tr> <tr><td>29</td><td></td><td></td><td></td><td></td><td></td><td></td></tr> <tr><td>21</td><td></td><td></td><td></td><td></td><td></td><td></td></tr> </tbody> </table>	S	S	M	T	W	T	F	1	2	3	4	5	6	7	24	25	26	27	28	29	30	8	9	10	11	12	13	14	31	1	2	3	4	5	6	15	16	17	18	19	20	21	7	8	9	10	11	12	13	22	23	24	25	26	27	28	14	15	16	17	18	19	20	29							21							<p style="text-align: center;">Jumaadi II 1433 Apr - May 2012</p> <table border="1"> <thead> <tr><th>S</th><th>S</th><th>M</th><th>T</th><th>W</th><th>T</th><th>F</th></tr> </thead> <tbody> <tr><td></td><td>1</td><td>2</td><td>3</td><td>4</td><td>5</td><td>6</td></tr> <tr><td></td><td>22</td><td>23</td><td>24</td><td>25</td><td>26</td><td>27</td></tr> <tr><td>7</td><td>8</td><td>9</td><td>10</td><td>11</td><td>12</td><td>13</td></tr> <tr><td>28</td><td>29</td><td>30</td><td>1</td><td>2</td><td>3</td><td>4</td></tr> <tr><td>14</td><td>15</td><td>16</td><td>17</td><td>18</td><td>19</td><td>20</td></tr> <tr><td>5</td><td>6</td><td>7</td><td>8</td><td>9</td><td>10</td><td>11</td></tr> <tr><td>21</td><td>22</td><td>23</td><td>24</td><td>25</td><td>26</td><td>27</td></tr> <tr><td>12</td><td>13</td><td>14</td><td>15</td><td>16</td><td>17</td><td>18</td></tr> <tr><td>28</td><td>29</td><td>30</td><td></td><td></td><td></td><td></td></tr> <tr><td>19</td><td>20</td><td>21</td><td></td><td></td><td></td><td></td></tr> </tbody> </table>	S	S	M	T	W	T	F		1	2	3	4	5	6		22	23	24	25	26	27	7	8	9	10	11	12	13	28	29	30	1	2	3	4	14	15	16	17	18	19	20	5	6	7	8	9	10	11	21	22	23	24	25	26	27	12	13	14	15	16	17	18	28	29	30					19	20	21																		
S	S	M	T	W	T	F																																																																																																																																																																																																																																																	
					1	2																																																																																																																																																																																																																																																	
					23	24																																																																																																																																																																																																																																																	
3	4	5	6	7	8	9																																																																																																																																																																																																																																																	
25	26	27	28	29	1	2																																																																																																																																																																																																																																																	
10	11	12	13	14	15	16																																																																																																																																																																																																																																																	
3	4	5	6	7	8	9																																																																																																																																																																																																																																																	
17	18	19	20	21	22	23																																																																																																																																																																																																																																																	
10	11	12	13	14	15	16																																																																																																																																																																																																																																																	
24	25	26	27	28	29	30																																																																																																																																																																																																																																																	
17	18	19	20	21	22	23																																																																																																																																																																																																																																																	
S	S	M	T	W	T	F																																																																																																																																																																																																																																																	
1	2	3	4	5	6	7																																																																																																																																																																																																																																																	
24	25	26	27	28	29	30																																																																																																																																																																																																																																																	
8	9	10	11	12	13	14																																																																																																																																																																																																																																																	
31	1	2	3	4	5	6																																																																																																																																																																																																																																																	
15	16	17	18	19	20	21																																																																																																																																																																																																																																																	
7	8	9	10	11	12	13																																																																																																																																																																																																																																																	
22	23	24	25	26	27	28																																																																																																																																																																																																																																																	
14	15	16	17	18	19	20																																																																																																																																																																																																																																																	
29																																																																																																																																																																																																																																																							
21																																																																																																																																																																																																																																																							
S	S	M	T	W	T	F																																																																																																																																																																																																																																																	
	1	2	3	4	5	6																																																																																																																																																																																																																																																	
	22	23	24	25	26	27																																																																																																																																																																																																																																																	
7	8	9	10	11	12	13																																																																																																																																																																																																																																																	
28	29	30	1	2	3	4																																																																																																																																																																																																																																																	
14	15	16	17	18	19	20																																																																																																																																																																																																																																																	
5	6	7	8	9	10	11																																																																																																																																																																																																																																																	
21	22	23	24	25	26	27																																																																																																																																																																																																																																																	
12	13	14	15	16	17	18																																																																																																																																																																																																																																																	
28	29	30																																																																																																																																																																																																																																																					
19	20	21																																																																																																																																																																																																																																																					
<p style="text-align: center;">Rajab 1433 May - Jun 2012</p> <table border="1"> <thead> <tr><th>S</th><th>S</th><th>M</th><th>T</th><th>W</th><th>T</th><th>F</th></tr> </thead> <tbody> <tr><td></td><td></td><td></td><td>1</td><td>2</td><td>3</td><td>4</td></tr> <tr><td></td><td></td><td></td><td>22</td><td>23</td><td>24</td><td>25</td></tr> <tr><td>5</td><td>6</td><td>7</td><td>8</td><td>9</td><td>10</td><td>11</td></tr> <tr><td>26</td><td>27</td><td>28</td><td>29</td><td>30</td><td>31</td><td>1</td></tr> <tr><td>12</td><td>13</td><td>14</td><td>15</td><td>16</td><td>17</td><td>18</td></tr> <tr><td>2</td><td>3</td><td>4</td><td>5</td><td>6</td><td>7</td><td>8</td></tr> <tr><td>19</td><td>20</td><td>21</td><td>22</td><td>23</td><td>24</td><td>25</td></tr> <tr><td>9</td><td>10</td><td>11</td><td>12</td><td>13</td><td>14</td><td>15</td></tr> <tr><td>26</td><td>27</td><td>28</td><td>29</td><td>30</td><td></td><td></td></tr> <tr><td>16</td><td>17</td><td>18</td><td>19</td><td>20</td><td></td><td></td></tr> </tbody> </table>	S	S	M	T	W	T	F				1	2	3	4				22	23	24	25	5	6	7	8	9	10	11	26	27	28	29	30	31	1	12	13	14	15	16	17	18	2	3	4	5	6	7	8	19	20	21	22	23	24	25	9	10	11	12	13	14	15	26	27	28	29	30			16	17	18	19	20			<p style="text-align: center;">SHa'baan 1433 Jun - Jul 2012</p> <table border="1"> <thead> <tr><th>S</th><th>S</th><th>M</th><th>T</th><th>W</th><th>T</th><th>F</th></tr> </thead> <tbody> <tr><td></td><td></td><td></td><td></td><td></td><td>1</td><td>2</td></tr> <tr><td></td><td></td><td></td><td></td><td></td><td>21</td><td>22</td></tr> <tr><td>3</td><td>4</td><td>5</td><td>6</td><td>7</td><td>8</td><td>9</td></tr> <tr><td>23</td><td>24</td><td>25</td><td>26</td><td>27</td><td>28</td><td>29</td></tr> <tr><td>10</td><td>11</td><td>12</td><td>13</td><td>14</td><td>15</td><td>16</td></tr> <tr><td>30</td><td>1</td><td>2</td><td>3</td><td>4</td><td>5</td><td>6</td></tr> <tr><td>17</td><td>18</td><td>19</td><td>20</td><td>21</td><td>22</td><td>23</td></tr> <tr><td>7</td><td>8</td><td>9</td><td>10</td><td>11</td><td>12</td><td>13</td></tr> <tr><td>24</td><td>25</td><td>26</td><td>27</td><td>28</td><td>29</td><td></td></tr> <tr><td>14</td><td>15</td><td>16</td><td>17</td><td>18</td><td>19</td><td></td></tr> </tbody> </table>	S	S	M	T	W	T	F						1	2						21	22	3	4	5	6	7	8	9	23	24	25	26	27	28	29	10	11	12	13	14	15	16	30	1	2	3	4	5	6	17	18	19	20	21	22	23	7	8	9	10	11	12	13	24	25	26	27	28	29		14	15	16	17	18	19		<p style="text-align: center;">RamaDhaan 1433 Jul - Aug 2012</p> <table border="1"> <thead> <tr><th>S</th><th>S</th><th>M</th><th>T</th><th>W</th><th>T</th><th>F</th></tr> </thead> <tbody> <tr><td></td><td></td><td></td><td></td><td></td><td></td><td>1</td></tr> <tr><td></td><td></td><td></td><td></td><td></td><td></td><td>20</td></tr> <tr><td>2</td><td>3</td><td>4</td><td>5</td><td>6</td><td>7</td><td>8</td></tr> <tr><td>21</td><td>22</td><td>23</td><td>24</td><td>25</td><td>26</td><td>27</td></tr> <tr><td>9</td><td>10</td><td>11</td><td>12</td><td>13</td><td>14</td><td>15</td></tr> <tr><td>28</td><td>29</td><td>30</td><td>31</td><td>1</td><td>2</td><td>3</td></tr> <tr><td>16</td><td>17</td><td>18</td><td>19</td><td>20</td><td>21</td><td>22</td></tr> <tr><td>4</td><td>5</td><td>6</td><td>7</td><td>8</td><td>9</td><td>10</td></tr> <tr><td>23</td><td>24</td><td>25</td><td>26</td><td>27</td><td>28</td><td>29</td></tr> <tr><td>11</td><td>12</td><td>13</td><td>14</td><td>15</td><td>16</td><td>17</td></tr> <tr><td>30</td><td></td><td></td><td></td><td></td><td></td><td></td></tr> <tr><td>18</td><td></td><td></td><td></td><td></td><td></td><td></td></tr> </tbody> </table>	S	S	M	T	W	T	F							1							20	2	3	4	5	6	7	8	21	22	23	24	25	26	27	9	10	11	12	13	14	15	28	29	30	31	1	2	3	16	17	18	19	20	21	22	4	5	6	7	8	9	10	23	24	25	26	27	28	29	11	12	13	14	15	16	17	30							18						
S	S	M	T	W	T	F																																																																																																																																																																																																																																																	
			1	2	3	4																																																																																																																																																																																																																																																	
			22	23	24	25																																																																																																																																																																																																																																																	
5	6	7	8	9	10	11																																																																																																																																																																																																																																																	
26	27	28	29	30	31	1																																																																																																																																																																																																																																																	
12	13	14	15	16	17	18																																																																																																																																																																																																																																																	
2	3	4	5	6	7	8																																																																																																																																																																																																																																																	
19	20	21	22	23	24	25																																																																																																																																																																																																																																																	
9	10	11	12	13	14	15																																																																																																																																																																																																																																																	
26	27	28	29	30																																																																																																																																																																																																																																																			
16	17	18	19	20																																																																																																																																																																																																																																																			
S	S	M	T	W	T	F																																																																																																																																																																																																																																																	
					1	2																																																																																																																																																																																																																																																	
					21	22																																																																																																																																																																																																																																																	
3	4	5	6	7	8	9																																																																																																																																																																																																																																																	
23	24	25	26	27	28	29																																																																																																																																																																																																																																																	
10	11	12	13	14	15	16																																																																																																																																																																																																																																																	
30	1	2	3	4	5	6																																																																																																																																																																																																																																																	
17	18	19	20	21	22	23																																																																																																																																																																																																																																																	
7	8	9	10	11	12	13																																																																																																																																																																																																																																																	
24	25	26	27	28	29																																																																																																																																																																																																																																																		
14	15	16	17	18	19																																																																																																																																																																																																																																																		
S	S	M	T	W	T	F																																																																																																																																																																																																																																																	
						1																																																																																																																																																																																																																																																	
						20																																																																																																																																																																																																																																																	
2	3	4	5	6	7	8																																																																																																																																																																																																																																																	
21	22	23	24	25	26	27																																																																																																																																																																																																																																																	
9	10	11	12	13	14	15																																																																																																																																																																																																																																																	
28	29	30	31	1	2	3																																																																																																																																																																																																																																																	
16	17	18	19	20	21	22																																																																																																																																																																																																																																																	
4	5	6	7	8	9	10																																																																																																																																																																																																																																																	
23	24	25	26	27	28	29																																																																																																																																																																																																																																																	
11	12	13	14	15	16	17																																																																																																																																																																																																																																																	
30																																																																																																																																																																																																																																																							
18																																																																																																																																																																																																																																																							
<p style="text-align: center;">SHawal 1433 Aug - Sep 2012</p> <table border="1"> <thead> <tr><th>S</th><th>S</th><th>M</th><th>T</th><th>W</th><th>T</th><th>F</th></tr> </thead> <tbody> <tr><td></td><td>1</td><td>2</td><td>3</td><td>4</td><td>5</td><td>6</td></tr> <tr><td></td><td>19</td><td>20</td><td>21</td><td>22</td><td>23</td><td>24</td></tr> <tr><td>7</td><td>8</td><td>9</td><td>10</td><td>11</td><td>12</td><td>13</td></tr> <tr><td>25</td><td>26</td><td>27</td><td>28</td><td>29</td><td>30</td><td>31</td></tr> <tr><td>14</td><td>15</td><td>16</td><td>17</td><td>18</td><td>19</td><td>20</td></tr> <tr><td>1</td><td>2</td><td>3</td><td>4</td><td>5</td><td>6</td><td>7</td></tr> <tr><td>21</td><td>22</td><td>23</td><td>24</td><td>25</td><td>26</td><td>27</td></tr> <tr><td>8</td><td>9</td><td>10</td><td>11</td><td>12</td><td>13</td><td>14</td></tr> <tr><td>28</td><td>29</td><td></td><td></td><td></td><td></td><td></td></tr> <tr><td>15</td><td>16</td><td></td><td></td><td></td><td></td><td></td></tr> </tbody> </table>	S	S	M	T	W	T	F		1	2	3	4	5	6		19	20	21	22	23	24	7	8	9	10	11	12	13	25	26	27	28	29	30	31	14	15	16	17	18	19	20	1	2	3	4	5	6	7	21	22	23	24	25	26	27	8	9	10	11	12	13	14	28	29						15	16						<p style="text-align: center;">Thu al-Qi'dah 1433 Sep - October 2012</p> <table border="1"> <thead> <tr><th>S</th><th>S</th><th>M</th><th>T</th><th>W</th><th>T</th><th>F</th></tr> </thead> <tbody> <tr><td></td><td></td><td>1</td><td>2</td><td>3</td><td>4</td><td>5</td></tr> <tr><td></td><td></td><td>17</td><td>18</td><td>19</td><td>20</td><td>21</td></tr> <tr><td>6</td><td>7</td><td>8</td><td>9</td><td>10</td><td>11</td><td>12</td></tr> <tr><td>22</td><td>23</td><td>24</td><td>25</td><td>26</td><td>27</td><td>28</td></tr> <tr><td>13</td><td>14</td><td>15</td><td>16</td><td>17</td><td>18</td><td>19</td></tr> <tr><td>29</td><td>30</td><td>1</td><td>2</td><td>3</td><td>4</td><td>5</td></tr> <tr><td>20</td><td>21</td><td>22</td><td>23</td><td>24</td><td>25</td><td>26</td></tr> <tr><td>6</td><td>7</td><td>8</td><td>9</td><td>10</td><td>11</td><td>12</td></tr> <tr><td>27</td><td>28</td><td>29</td><td>30</td><td></td><td></td><td></td></tr> <tr><td>13</td><td>14</td><td>15</td><td>16</td><td></td><td></td><td></td></tr> </tbody> </table>	S	S	M	T	W	T	F			1	2	3	4	5			17	18	19	20	21	6	7	8	9	10	11	12	22	23	24	25	26	27	28	13	14	15	16	17	18	19	29	30	1	2	3	4	5	20	21	22	23	24	25	26	6	7	8	9	10	11	12	27	28	29	30				13	14	15	16				<p style="text-align: center;">Thu al-Hijjah 1433 Oct - Nov 2012</p> <table border="1"> <thead> <tr><th>S</th><th>S</th><th>M</th><th>T</th><th>W</th><th>T</th><th>F</th></tr> </thead> <tbody> <tr><td></td><td></td><td></td><td></td><td>1</td><td>2</td><td>3</td></tr> <tr><td></td><td></td><td></td><td></td><td>17</td><td>18</td><td>19</td></tr> <tr><td>4</td><td>5</td><td>6</td><td>7</td><td>8</td><td>9</td><td>10</td></tr> <tr><td>20</td><td>21</td><td>22</td><td>23</td><td>24</td><td>25</td><td>26</td></tr> <tr><td>11</td><td>12</td><td>13</td><td>14</td><td>15</td><td>16</td><td>17</td></tr> <tr><td>27</td><td>28</td><td>29</td><td>30</td><td>31</td><td>1</td><td>2</td></tr> <tr><td>18</td><td>19</td><td>20</td><td>21</td><td>22</td><td>23</td><td>24</td></tr> <tr><td>3</td><td>4</td><td>5</td><td>6</td><td>7</td><td>8</td><td>9</td></tr> <tr><td>25</td><td>26</td><td>27</td><td>28</td><td>29</td><td>10</td><td>Days</td></tr> <tr><td>10</td><td>11</td><td>12</td><td>13</td><td>14</td><td></td><td></td></tr> </tbody> </table>	S	S	M	T	W	T	F					1	2	3					17	18	19	4	5	6	7	8	9	10	20	21	22	23	24	25	26	11	12	13	14	15	16	17	27	28	29	30	31	1	2	18	19	20	21	22	23	24	3	4	5	6	7	8	9	25	26	27	28	29	10	Days	10	11	12	13	14																
S	S	M	T	W	T	F																																																																																																																																																																																																																																																	
	1	2	3	4	5	6																																																																																																																																																																																																																																																	
	19	20	21	22	23	24																																																																																																																																																																																																																																																	
7	8	9	10	11	12	13																																																																																																																																																																																																																																																	
25	26	27	28	29	30	31																																																																																																																																																																																																																																																	
14	15	16	17	18	19	20																																																																																																																																																																																																																																																	
1	2	3	4	5	6	7																																																																																																																																																																																																																																																	
21	22	23	24	25	26	27																																																																																																																																																																																																																																																	
8	9	10	11	12	13	14																																																																																																																																																																																																																																																	
28	29																																																																																																																																																																																																																																																						
15	16																																																																																																																																																																																																																																																						
S	S	M	T	W	T	F																																																																																																																																																																																																																																																	
		1	2	3	4	5																																																																																																																																																																																																																																																	
		17	18	19	20	21																																																																																																																																																																																																																																																	
6	7	8	9	10	11	12																																																																																																																																																																																																																																																	
22	23	24	25	26	27	28																																																																																																																																																																																																																																																	
13	14	15	16	17	18	19																																																																																																																																																																																																																																																	
29	30	1	2	3	4	5																																																																																																																																																																																																																																																	
20	21	22	23	24	25	26																																																																																																																																																																																																																																																	
6	7	8	9	10	11	12																																																																																																																																																																																																																																																	
27	28	29	30																																																																																																																																																																																																																																																				
13	14	15	16																																																																																																																																																																																																																																																				
S	S	M	T	W	T	F																																																																																																																																																																																																																																																	
				1	2	3																																																																																																																																																																																																																																																	
				17	18	19																																																																																																																																																																																																																																																	
4	5	6	7	8	9	10																																																																																																																																																																																																																																																	
20	21	22	23	24	25	26																																																																																																																																																																																																																																																	
11	12	13	14	15	16	17																																																																																																																																																																																																																																																	
27	28	29	30	31	1	2																																																																																																																																																																																																																																																	
18	19	20	21	22	23	24																																																																																																																																																																																																																																																	
3	4	5	6	7	8	9																																																																																																																																																																																																																																																	
25	26	27	28	29	10	Days																																																																																																																																																																																																																																																	
10	11	12	13	14																																																																																																																																																																																																																																																			

Hijri 1433AH / Gregorian 2012AD Calendar with the Merciful Verse days highlighted (± 1 day error margin with Islamic days start at sunset of the previous day)

Here is a table listing the Merciful Verse days starting at sunset of that day.

Word				Dates			
فبأى	ءالء	ربكما	تكذبان	فبأى	ءالء	ربكما	تكذبان
44	45	46	47	2012-01-07	2012-01-08	2012-01-09	2012-01-10
59	60	61	62	2012-01-22	2012-01-23	2012-01-24	2012-01-25
67	68	69	70	2012-01-30	2012-01-31	2012-02-01	2012-02-02
78	79	80	81	2012-02-10	2012-02-11	2012-02-12	2012-02-13
86	87	88	89	2012-02-18	2012-02-19	2012-02-20	2012-02-21
96	97	98	99	2012-02-28	2012-02-29	2012-03-01	2012-03-02
110	111	112	113	2012-03-13	2012-03-14	2012-03-15	2012-03-16
124	125	126	127	2012-03-27	2012-03-28	2012-03-29	2012-03-30
132	133	134	135	2012-04-04	2012-04-05	2012-04-06	2012-04-07
152	153	154	155	2012-04-24	2012-04-25	2012-04-26	2012-04-27
164	165	166	167	2012-05-06	2012-05-07	2012-05-08	2012-05-09
174	175	176	177	2012-05-16	2012-05-17	2012-05-18	2012-05-19
186	187	188	189	2012-05-28	2012-05-29	2012-05-30	2012-05-31
196	197	198	199	2012-06-07	2012-06-08	2012-06-09	2012-06-10
211	212	213	214	2012-06-22	2012-06-23	2012-06-24	2012-06-25
220	221	222	223	2012-07-01	2012-07-02	2012-07-03	2012-07-04
226	227	228	229	2012-07-07	2012-07-08	2012-07-09	2012-07-10
233	234	235	236	2012-07-14	2012-07-15	2012-07-16	2012-07-17
242	243	244	245	2012-07-23	2012-07-24	2012-07-25	2012-07-26
255	256	257	258	2012-08-05	2012-08-06	2012-08-07	2012-08-08
268	269	270	271	2012-08-18	2012-08-19	2012-08-20	2012-08-21
275	276	277	278	2012-08-25	2012-08-26	2012-08-27	2012-08-28
284	285	286	287	2012-09-03	2012-09-04	2012-09-05	2012-09-06
291	292	293	294	2012-09-10	2012-09-11	2012-09-12	2012-09-13
296	297	298	299	2012-09-15	2012-09-16	2012-09-17	2012-09-18
303	304	305	306	2012-09-22	2012-09-23	2012-09-24	2012-09-25
311	312	313	314	2012-09-30	2012-10-01	2012-10-02	2012-10-03
318	319	320	321	2012-10-07	2012-10-08	2012-10-09	2012-10-10
326	327	328	329	2012-10-15	2012-10-16	2012-10-17	2012-10-18
336	337	338	339	2012-10-25	2012-10-26	2012-10-27	2012-10-28
346	347	348	349	2012-11-04	2012-11-05	2012-11-06	2012-11-07

Mapping words of The Merciful chapter to days in 2012AD
 (±1 day error margin with Islamic days start at sunset of these days)

It is therefore speculated that a **four-day event** will **repeat 31 times** before a **big event** takes place as revenge against those who disbelieve and belie God's signs and bounties (ءالاء) and go one to spread injustice in the land as might be hinted to by Allah Almighty in Quran 44:10-16:

أعوذ بالله من الشيطان الرجيم بسم الله الرحمن الرحيم

10. فَأَرْقَبُ يَوْمَ تَأْتِي السَّمَاءُ بِدُخَانٍ مُّبِينٍ
11. يَغشى النَّاسَ هَذَا عَذَابٌ أَلِيمٌ
12. رَبَّنَا اكشِفْ عَنَّا الْعَذَابَ إِنَّا مُؤْمِنُونَ
13. أَلَيْسَ لَهُمُ الذِّكْرَى وَقَدْ جَاءَهُمْ رَسُولٌ مُّبِينٌ
14. ثُمَّ تَوَلَّوْا عَنْهُ وَقَالُوا مُعَلِّمٌ مِّثْلُنَا
15. إِنَّا كَاشِفُوا الْعَذَابَ قَلِيلًا إِنَّكُمْ عَائِدُونَ
16. يَوْمَ نَبْطِشُ الْبَطِشَةَ الْكُبْرَى إِنَّا مُنْتَقِمُونَ

10. *Lookout for the day when the heaven shall bring an evident **smoke**,*
11. *That shall cover people; this is a painful punishment.*
12. *Oh Lord! Please take away this punishment from us; surely we are believers.*
13. *Do not they remember when there came to them a clarifying messenger!*
14. *Yet they turned their backs on him and said: a taught madman.*
15. *We are removing the punishment a little, but surely you will **return** (to evil).*
16. *On a day when We seize (them) with a **mighty onslaught**; We are taking revenge.*

Note that **10th** Muharram of **61AH** was *Aashooraa* (عاشوراء) the day on which Imam Husain (as), the grandson of the Prophet Muhammed (pbuh+f) was killed by the enemy of Allah and it is on the same anniversary that Muslims expect the second coming of Imam Mehdi (may Allah bring forward his reappearance) to restore peace and justice on Earth and to take revenge for that savage killing of Imam Husain (as) and his true followers.

Therefore, the **first 10 days of Muharram 1434AH** could in fact be the time for that revenge but only Allah knows/decides when His **mighty onslaught** will come, very soon in sha Allah. ☺

Further evidence that sunlight will be blocked out sometime in the future (perhaps by Earth **encirclating** smoke from the sky or by **cascading** volcanic eruptions) can be found in Quran 36:37:

أعوذ بالله من الشيطان الرجيم بسم الله الرحمن الرحيم

”وَعَايَةً لَهُمُ اللَّيْلُ نَسْلُجٌ مِنْهُ النَّهَارَ فَإِذَا هُمْ مُظْلِمُونَ“

“And a sign for them the night **We peel** daylight out of it and behold they are plunged into darkness.”

Event Locations

A friend once asked me to try to find the locations of the 31 events to take place in 2012 and he suggested that I might look for numbers that may give hint to GPS coordinates or telephone area codes in a similar way to a movie he had watched called "**Knowing**" [[http://en.wikipedia.org/wiki/Knowing_\(film\)](http://en.wikipedia.org/wiki/Knowing_(film))].

For weeks, I struggled to find any geographic coordinates using the Merciful verse numbers with and without the chapter number but soon I realized that if each event is to last four days then what I ought to be looking at is not points on the Earth map but latitude lines (horizontal circles) if one can imagine 31 meteorite showers each lasting four days as a result of laser beams trying to disintegrate a Near Earth Object [<http://neo.jpl.nasa.gov>] threatening Earth in 2011.

Quranic chapter #105 vividly depicts such a pre-Islamic scenario that happened in Makkah shortly before the birth of the Prophet (pbuh+f):

أعوذ بالله من الشيطان الرجيم بِسْمِ اللَّهِ الرَّحْمَنِ الرَّحِيمِ

1. أَلَمْ تَرَ كَيْفَ فَعَلَ رَبُّكَ بِأَصْحَابِ الْفِيلِ
2. أَلَمْ يَجْعَلْ كَيْدَهُمْ فِي تَضَلِيلٍ
3. وَأَرْسَلَ عَلَيْهِمْ طَيْرًا أَبَابِيلَ
4. تَرْمِيهِمْ بِحِجَارَةٍ مِّن سِجِيلٍ
5. فَجَعَلَهُمْ كَعَصْفٍ مَّأْكُولٍ

1. Cannot you see how your Lord dealt with the people of elephant?
2. Did He not cause their plan to end in confusion?
3. And He send down upon them birds in flocks,
4. casting them with stones of baked clay?
5. So He rendered them like straw eaten up?

And here is the chapter commentary from [www.al-islam.org/quran]:

About fifty days before the birth of the Prophet (pbuh+f), Abraha, the Christian Abyssinia's viceroy of Yemen proceeded against Makkah, as the head of a large army, equipped with elephants with the aim of destroying the Kaabah, The House of God, at its center, so no other structure is more glorious than the church he was building at Sanaa, the capital of Yemen.

At the outskirts of Makkah he captured a large herd of camels belonging to the chief of Makkah, Abd al Muttalib, the grandfather of the Holy Prophet. On receiving the news, Abd al Muttalib went to him and told him:

"I have come to collect my camels. As for the Kaabah, it belongs to God and He will surely protect it from your evil desires."

Abd al Muttalib got his camels and returned to the city to warn people to retire to neighboring hills, leaving the Lord of the House to protect it.

When Abraha's army entered Makkah, a large flock of sparrows came flying from the sea-coast and pelted the invading army with pebbles of baked clay. They all died instantly and were left like a dead field of which all produce was eaten up and only straw with stubble was left.

Abraha escaped and went directly to the king in Abyssinia. All the way a sparrow with a stone in its beak followed him. When the king asked Abraha as to what kind of birds they were, Abraha looked up to the sky and the sparrow at once dropped the stone and killed him on the spot.

Such a scenario is very possible and if it happened, it would leave a shower trail along a full latitude circle for each day within a ~55 km zone to either side of it as calculated here:

Earth pole radius* $r \approx 6356$ km
Earth circumference $C = 2 \pi r \approx 39935$ km
Number of latitude lines $n = 180^\circ$ from -90° to $+90^\circ$
across the Height of Earth $H = C \div 2 \approx 19967$ km
Latitude line width $W = H \div n \approx 110.9$ km
Zone width on either side $z = W \div 2 \approx 55.47$ km

Here are the verse numbers again that could be references to latitudes:

13, 16, 18, 21, 23, 25, 28, 30, 32, 34, 36, 38, 40, 42, 45,
47, 49, 51, 53, 55, 57, 59, 61, 63, 65, 67, 69, 71, 73, 75, 77

And here is a table shows the latitudes for some Islamic holy places with their nearest latitude zones:

City, Country	Latitude	Longitude	Zone
Makkah, Saudi Arabia	21° 25' N	39° 49' E	21
Medina, Saudi Arabia	24° 28' N	39° 36' E	24
An-Najaf, Iraq	32° 00' N	44° 20' E	32
Karbala, Iraq	32° 37' N	44° 02' E	33
Samarra, Iraq	34° 12' N	43° 52' E	34
Mashhed, Iran	36° 18' N	59° 36' E	36
Al-Quds, Palestine	31° 47' N	35° 14' E	32

Latitudes and Longitudes of Islamic Holy Places on Earth

* The Earth's polar radius is the distance from its center to the North and South Poles $\approx 6,356$ km [http://en.wikipedia.org/wiki/Earth_radius#Polar_radius].

It appears from the above table that these 31 latitudes might actually be safe zones or these places will survive despite being in the danger zone for Allah Almighty already told us that **Makkah** is a **safe land** in Quran 95:3:

أعوذ بالله من الشيطان الرجيم بِسْمِ اللَّهِ الرَّحْمَنِ الرَّحِيمِ

1. وَالزَّيْتُونَ وَالزَّيْتُونَ
2. وَطُورِ سَيْنِينَ
3. وَهَذَا الْبَلَدِ الْأَمِينِ
4. لَقَدْ خَلَقْنَا الْإِنْسَانَ فِي أَحْسَن تَقْوِيمٍ
5. ثُمَّ رَدَدْنَاهُ أَسْفَلَ سَافِلِينَ
6. إِلَّا الَّذِينَ ءَامَنُوا وَعَمِلُوا الصَّالِحَاتِ فَلَهُمْ أَجْرٌ غَيْرُ مَمْنُونٍ
7. فَمَا يُكَذِّبُكَ بَعْدُ بِالذِّينِ
8. أَلَيْسَ اللَّهُ بِأَحْكَمَ الْحَاكِمِينَ

1. By the fig and the olive,
2. By Mount Sinai,
3. And by this land made safe;
4. Surely We created man of the best stature
5. Then we reduced him to the lowest of the low,
6. Except those who believe and do good deeds, their reward is never-ending.
7. So what makes you deny the Recompense (i.e. Day of Resurrection)?
8. Is not Allah the most just of judges?

WARNING

Therefore, it is possible that God All-knowing is warning us about **31** events to start on **7th Jan 2012** and end on **7th Nov 2012** each lasting **4 days**.

If these events are any kind of meteorite showers or similar kind of outer threat, then each event would sweep the Earth 4 times along a **latitude** circle as it completes 4 spins in 4 days.

Therefore, there may be **31 danger latitudes** that people should avoid and God, The All Merciful, is telling us exactly these latitudes as the numbers of the repeated verse in chapter #55 The Merciful, as follows:

**13° 16° 18° 21° 23° 25° 28° 30° 32° 34° 36° 38° 40°
42° 45° 47° 49° 51° 53° 55° 57° 59° 61° 63° 65° 67°
69° 71° 73° 75° 77°**

Indeed, to confirm that we are dealing with latitudes, Allah Almighty has made these 31 repeated verse numbers (13 – 77) sit exactly in the middle of the range 0 – 90 (the gap from 0 to 13 is 13 and the gap from 77 to 90 is also 13) as if to say that we should be looking for some quantity with a range of 0 to 90. Latitudes do indeed have this range 0° – 90° north and south.

Note that each latitude is **111 km** wide (with **0.5 degree** on either side) and runs around the whole Earth so some places will survive like religious places as was seen in the 2004 Tsunami.

If the first event occurs at latitude **13° North, South or both** as Allah is talking to two entities (man and jinn) in the repeated verse, **then** people must evacuate the next latitude of **16°** within **11** days as there are **11** words to the next verse repetition and so on for all other latitudes up to **77°**.

The following table shows the dates for all **31 latitudes** to within +/- 1 day but only Allah knows and controls everything at real time and can choose to change the course of history at anytime as we beg for mercy from Him, The All Merciful.

وَالْحَمْدُ لِلَّهِ رَبِّ الْعَالَمِينَ

Glory to Allah the Sustainer of all worlds, the Seen and Unseen.

2012 Events: Latitudes and Dates				
13°	2012-01-07	2012-01-08	2012-01-09	2012-01-10
16°	2012-01-22	2012-01-23	2012-01-24	2012-01-25
18°	2012-01-30	2012-01-31	2012-02-01	2012-02-02
21°	2012-02-10	2012-02-11	2012-02-12	2012-02-13
23°	2012-02-18	2012-02-19	2012-02-20	2012-02-21
25°	2012-02-28	2012-02-29	2012-03-01	2012-03-02
28°	2012-03-13	2012-03-14	2012-03-15	2012-03-16
30°	2012-03-27	2012-03-28	2012-03-29	2012-03-30
32°	2012-04-04	2012-04-05	2012-04-06	2012-04-07
34°	2012-04-24	2012-04-25	2012-04-26	2012-04-27
36°	2012-05-06	2012-05-07	2012-05-08	2012-05-09
38°	2012-05-16	2012-05-17	2012-05-18	2012-05-19
40°	2012-05-28	2012-05-29	2012-05-30	2012-05-31
42°	2012-06-07	2012-06-08	2012-06-09	2012-06-10
45°	2012-06-22	2012-06-23	2012-06-24	2012-06-25
47°	2012-07-01	2012-07-02	2012-07-03	2012-07-04
49°	2012-07-07	2012-07-08	2012-07-09	2012-07-10
51°	2012-07-14	2012-07-15	2012-07-16	2012-07-17
53°	2012-07-23	2012-07-24	2012-07-25	2012-07-26
55°	2012-08-05	2012-08-06	2012-08-07	2012-08-08
57°	2012-08-18	2012-08-19	2012-08-20	2012-08-21
59°	2012-08-25	2012-08-26	2012-08-27	2012-08-28
61°	2012-09-03	2012-09-04	2012-09-05	2012-09-06
63°	2012-09-10	2012-09-11	2012-09-12	2012-09-13
65°	2012-09-15	2012-09-16	2012-09-17	2012-09-18
67°	2012-09-22	2012-09-23	2012-09-24	2012-09-25
69°	2012-09-30	2012-10-01	2012-10-02	2012-10-03
71°	2012-10-07	2012-10-08	2012-10-09	2012-10-10
73°	2012-10-15	2012-10-16	2012-10-17	2012-10-18
75°	2012-10-25	2012-10-26	2012-10-27	2012-10-28
77°	2012-11-04	2012-11-05	2012-11-06	2012-11-07

Quran and 2192

This **big event** will certainly not be the End of the World because a even further date into future can be extracted from the same Merciful verse by concatenating its 31 repeated verse numbers right-to-left (Arabic direction) to make up a 62-digit number that is divisible by 7 and a 62-digit prime number checked with this Java applet at <http://www.alpertron.com.ar/ECM.HTM>:

77757371696765636159575553514947454240383634323028252321181613
= 7 ×

11108195956680805165653650502135350605769090617575464617311659

In a reverse operation, this new 62-digit prime is then split into new 31 2-digit numbers that are added together to produce yet another prime number with a prime digit sum (i.e. an additive prime number) as follows:

11+10+81+95+95+66+80+80+51+65+65+36+50+50+21+35+35+06+05+7
6+90+90+61+75+75+46+46+17+31+16+59 = **1619** with a prime digit sum of 1+6+1+9 = **17**, an additive prime indeed. 😊

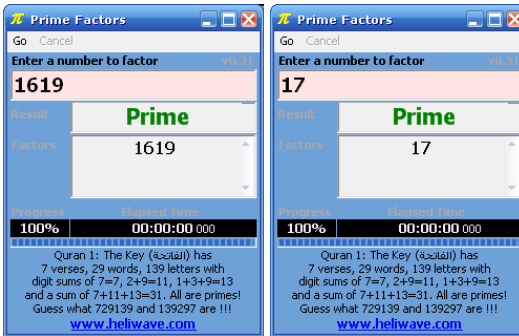

Prime Factorization of 1619 and 17

Future generations should watch out for the year **1619AH** or **2192AD** as yet another big correction (maybe 7 times stronger than the 2012 events). It is only Allah Who decides when the End of the World will come and it can arrive at anytime according to Quran 16:77:

أعوذ بالله من الشيطان الرجيم بسم الله الرحمن الرحيم

“وَلِلَّهِ غَيْبُ السَّمَوَاتِ وَالْأَرْضِ ۖ وَمَا أَمْرُ السَّاعَةِ إِلَّا كَلَمْحِ الْبَصَرِ أَوْ هُوَ أَقْرَبُ ۚ إِنَّ اللَّهَ عَلَىٰ كُلِّ شَيْءٍ قَدِيرٌ”

“To Allah belongs the Unseen of heavens and earth
and The Hour can come at the blink of an eye, or even nearer.
Truly! Allah is capable of doing anything.”

Prime Number Density

By now you would be forgiven to think that at least half of the numbers are primes and about half that is additive primes but the truth is such numbers are rarer and get even much rarer as we move up the ladder of natural numbers.

The following table assumes 1 to be a prime number. If 1 was excluded, then the prime density would be even rarer. While additive primes are those prime numbers with prime digit sums, "Pure Primes" is the name I gave for primes that are additive primes that have prime digits only (e.g. 7, 23, 313).

N	Primes		Additive Primes (Prime with Prime Digit Sum)		Pure Primes (Additive Prime with Prime Digits Only)	
	Count	Percentage	Count	Percentage	Count	Percentage
1	1	100.0%	1	100.0%	1	100.00%
10	5	50.0%	5	50.0%	5	50.00%
100	26	26.0%	15	15.0%	7	7.00%
1000	169	16.9%	90	9.0%	29	2.90%
10000	1230	12.3%	591	5.9%	86	0.86%
100000	9593	9.6%	3884	3.9%	320	0.32%
1000000	78499	7.9%	30124	3.0%	1021	0.10%
10000000	664580	6.6%	246983	2.5%	4201	0.04%
100000000	5761456	5.8%	2163900	2.2%	16440	0.02%
1000000000	50847535	5.1%	18661620	1.9%	73301	0.01%

Density of Prime, Additive Prime, and Pure Prime Numbers

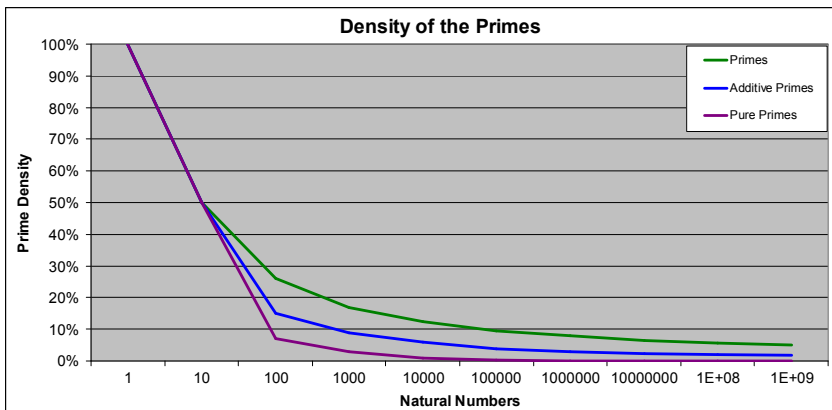

Density of Prime, Additive Prime, and Pure Prime Numbers

Primes are sometimes drawn along spirals to reveal patterns (of diagonal lines) and show density too. Ulam's Spiral is the most famous picture of the primes [<http://mathworld.wolfram.com/PrimeSpiral.html>] is shown here for the first 121 natural numbers:

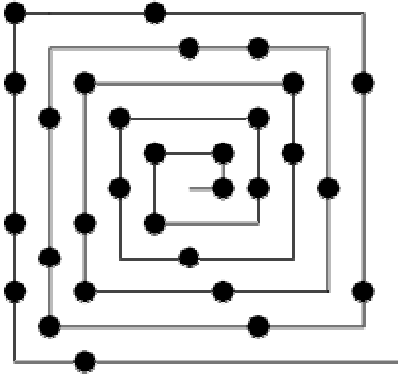

101	100	99	98	97	96	95	94	93	92	91
102	65	64	63	62	61	60	59	58	57	90
103	66	37	36	35	34	33	32	31	56	89
104	67	38	17	16	15	14	13	30	55	88
105	68	39	18	5	4	3	12	29	54	87
106	69	40	19	6	1	2	11	28	53	86
107	70	41	20	7	8	9	10	27	52	85
108	71	42	21	22	23	24	25	26	51	84
109	72	43	44	45	46	47	48	49	50	83
110	73	74	75	76	77	78	79	80	81	82
111	112	113	114	115	116	117	118	119	120	121

Ulam's Spiral of Prime Numbers

I have used his method for showing the density for both additive primes and pure primes but no obvious patterns were revealed as shown here for the first $150 \times 150 = 22500$ natural numbers:

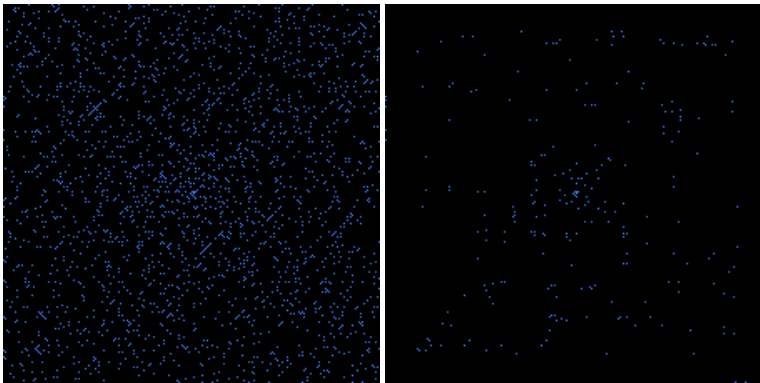

Ulam's Spiral of Additive Prime and Pure Prime Numbers

All I can see is a starry night [www.starrynight.com]. Meaningful patterns might be revealed if we use 3D arrangements instead, but that is for further research.

Further Research

This research is open to all who wish to help the group grow and become effective in awakening the general public to take heed and be ready to meet our Creator instead of the endless pursuit of worldly desires and materialism.

Our souls need to conform to the commands of our spirits to please Allah alone and be ready to fight the forces of evil under the banner of Imam Mehdi and Prophet Jesus (may peace be upon them both).

Muslims and non-Muslims alike need to think collectively as a unit, not as islands of knowledge, despite our differences to try our best to decode Allah's Message using prime numbers amongst other tools and to make noble use of it for the good of all, not the selfish few.

God orders us to contemplate the Quran and study its miracles and one such miracle is its structure. By now, it should be clear that prime numbers are *the key* to unlocking some of its hidden secrets and thanks to Allah the first such secret has been revealed in the right time to allow people of the Earth to prepare and pray for mercy as the year **2012** approaches.

Search Methods

Further research will look at various methods such as **skipping** a prime number of letters or words, **shifting** letters by different prime numbers depending on their positions within words, verses or chapters, or most likely **arranging** letters in **3D cubes** of various prime dimensions and joining letters horizontally, vertically and diagonally with prime distances to find hidden knowledge with Allah's permission.

This whole area is wide open for suggestions and will need the participation of many minds to come up with the right method, or through an inspirational moment from Allah Almighty, if He so wishes (in sha Allah).

Numbers in Nature

With permission and help from Allah Almighty, other numbers in nature such as Fibonacci numbers can be used to search for hidden words and perhaps phrases within the Quranic text by shifting and/or skipping distances of letters in accordance with the numbers in the series.

Irrational, transcendental numbers such as π and e [http://en.wikipedia.org/wiki/Transcendental_number] can be looked at to find out what hidden knowledge lives within their infinite decimal digits. They too can provide shifting and/or skipping distances.

Alternatively, the Golden Ratio ϕ could be used to shift or skip letter distances equal to the ratio or its reciprocal Φ .

Pythagorean Triples, Fibonacci numbers, Perfect numbers or even the simple square numbers can also be used to either find a decoding method or help in the search for the elusive magical formula for the N^{th} prime number.

And just to show how fun numbers can be, here is a mathematical joke for those who know their complex numbers from their irrational ones ☺

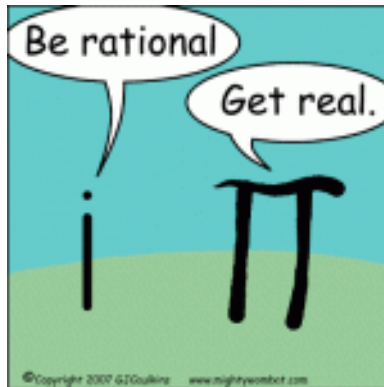

A Mathematical Joke ☺

Squared Numbers

Here is Quran #103 (*The Afternoon*) with its unmistakable reference to simple square numbers and perhaps indirect reference to sum of odd numbers:

أَعُوذُ بِاللَّهِ مِنَ الشَّيْطَانِ الرَّجِيمِ بِسْمِ اللَّهِ الرَّحْمَنِ الرَّحِيمِ

1.	وَالْعَصْرِ
2.	إِنَّ الْإِنْسَانَ لِفِي خُسْرٍ
3.	إِلَّا الَّذِينَ ءَامَنُوا وَعَمِلُوا الصَّالِحَاتِ وَتَوَاصَوْا بِالْحَقِّ وَتَوَاصَوْا بِالصَّبْرِ

1. I swear by the time,
 2. Most surely man is in loss,
 3. Except those who believe and do good, and enjoin on each other truth, and enjoin on each other patience.

See that verse 1 has **1** word, verse 2 has **4** words, and verse 3 has **9** words. That clearly shows the number of words is the square of the verse numbers while it is a fact that:

Sum of the first N odd numbers always equals to N^2

For example:

N	Sum of first N odds	N^2
1	1	1
2	1+3	4
3	1+3+5	9
4	1+3+5+7	16
5	1+3+5+7+9	25
o	1+3+5+...+o	o^2

Pythagorean Triples

Quran chapter #18 (*The Cave*) tells the story of Youth of the Cave spanning verse 9 to verse 25, a total of 17 verses and 313 words.

This chapter is recommended to be recited at the time of great confusion so not to be mistaken the Dajjal (the Anti-Christ) as Imam Mehdi (may Allah bring forward his reappearance) with his 313 generals. The fact that 313 is an additive number is significant but the fact that this story is strongly related to his blessed reappearance has the same number of words as his number of generals is simply astonishing!

What's more, looking at the Word Count tool of Microsoft Word, it reports 1,618 letters including spaces. Is that hint to the Golden Ratio of 1.618? Is that a hint from Allah that we must also treat spaces as letters?



Word Count of the Quranic story of Youth of the Cave

Nothing happens by coincident and the fact that this story start at verse 9 and end at verse 25 strongly hints at squares with a square difference ($25 - 9 = 16$). This is indeed a reference to the first Pythagorean Triples (3, 4, 5): [http://en.wikipedia.org/wiki/Pythagorean_triple].

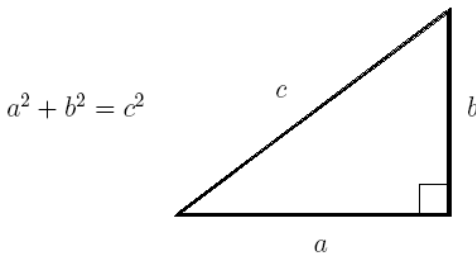

Pythagorean Theorem for Right Triangle

Here is story of Youth of the Cave in Quran 18:9-25:

أَعُوذُ بِاللَّهِ مِنَ الشَّيْطَانِ الرَّجِيمِ بِسْمِ اللَّهِ الرَّحْمَنِ الرَّحِيمِ

9. أَمْ حَسِبْتُمْ أَنْ أَصْحَابَ الْكَهْفِ وَالرَّقِيمِ كَانُوا مِنْ آيَاتِنَا عَجَبًا
10. إِذْ أَوْىٰ آلِفِيئِهِ إِلَى الْكَهْفِ فَقَالُوا رَبَّنَا آتِنَا مِنْ لَدُنْكَ رَحْمَةً وَهَيِّئْ لَنَا مِنْ أَمْرِنَا رَشَدًا
11. فَضَرَبْنَا عَلَىٰ آذَانِهِمْ فِي الْكَهْفِ سِنِينَ عَدَدًا
12. ثُمَّ بَعَثْنَا لِنَعْلَمَ أَيُّ الْحِزْبَيْنِ أَحْصَىٰ لِمَا لَبِئُوا أَمَدًا
13. نَحْنُ نَقُصُّ عَلَيْكَ نَبَأَهُم بِالْحَقِّ إِنَّهُمْ فِتْيَةٌ آمَنُوا بِرَبِّهِمْ وَرَدْنَاهُمْ هُدًى
14. وَرَبَطْنَا عَلَىٰ قُلُوبِهِمْ إِذْ قَامُوا فَقَالُوا رَبُّنَا رَبُّ السَّمَوَاتِ وَالْأَرْضِ لَنْ نَدْعُوَا مِنْ دُونِهِ إِلَّا هِيَ تَقْدُ فُلْنَا إِذْ شَطَطَا
15. هَؤُلَاءِ قَوْمًا اتَّخَذُوا مِنْ دُونِهِ ءَالِهَةً لَوْ لَانَا يَأْتُونَ عَلَيْهِمْ بِسُلْطَنٍ بَيْنَ يَدَيْهِمْ لَمْ أَكُنْ مِنْكُمْ مِمَّنْ أَقَرَّرَىٰ عَلَىٰ آلِهِ كَذِبًا
16. وَإِذْ أَعْتَرَلْتُمُوهُمْ وَمَا يَعْبُدُونَ إِلَّا اللَّهُ فَأَوَّا إِلَى الْكَهْفِ بِشَرِّ لَكُمْ رَبِّكُمْ مِنْ رَحْمَتِهِ وَيَهَيِّئْ لَكُمْ مِنْ أَمْرِكُمْ مَرِّفَقًا
17. ﴿٥٠﴾ وَتَرَى السَّمْسَ إِذَا طَلَعَتْ تَرُورُ عَنْ كَهْفِهِمْ ذَاتَ الْيَمِينِ وَإِذَا غَرَبَتْ تَقَرُّضُهُمْ ذَاتَ الشَّمَالِ وَهُمْ فِي فَجْوَةٍ مِنْهُ ؕ ذَلِكَ مِنْ ءَايَاتِ اللَّهِ لَعَلَّ مَنْ يَهْدَى اللَّهُ فَيُهْدَى اللَّهُ فَهُوَ الْمُهْتَدِ ؕ
18. وَمَنْ يَضِلْ فَلَنْ نَجِدَ لَهُ وَلِيًّا مُرْسِدًا
19. وَتَحْسَبُهُمْ آيَاطًا وَهُمْ رُفُودٌ وَنَقَلْبُهُمْ ذَاتَ الْيَمِينِ وَذَاتَ الشَّمَالِ ؕ وَكَلْبُهُمْ بَاسِطٌ ذِرَاعَيْهِ بِالْوَصِيدِ ؕ لَوِ اطَّلَعْتَ عَلَيْهِمْ لَوَلَّيْتَ مِنْهُمْ فِرَارًا وَلَمْ لَمَّتْ مِنْهُمْ رُعْبًا
20. وَكَذَلِكَ بَعَثْنَا لِنَبِّئَهُمْ لِيَتَسَاءَلُوا بَيْنَهُمْ ؕ قَالَ قَائِلٌ مِنْهُمْ كَمْ لَبِئْتُمْ ؕ قَالُوا لَبِئْنَا يَوْمًا أَوْ بَعْضَ يَوْمٍ ؕ قَالُوا رَبُّكُمْ أَعْلَمُ بِمَا لَبِئْتُمْ فَابْعَثُوا أَحَدَكُمْ بِوَرِقِكُمْ هَذِهِ إِلَى الْمَدِينَةِ فَلْيَنْظُرْ أَيُّهَا أَزْكَىٰ طَعَامًا فَلْيَأْتِكُمْ بِرِزْقٍ مِنْهُ وَلْيَتَلَطَّفْ وَلَا يُسْعِرَنَّ بِكُمْ أَحَدًا
21. إِنَّهُمْ إِنْ يَظْهَرُوا عَلَيْكُمْ يَرْجُمُوكُمْ أَوْ يُعِيدُوكُمْ فِي مِلَّتِهِمْ وَلَنْ تُفْلِحُوا إِذًا أَبَدًا
22. وَكَذَلِكَ أَعْتَرْنَا عَلَيْهِمْ لِيَعْلَمُوا أَن وَعْدَ اللَّهِ حَقٌّ وَأَنَّ السَّاعَةَ لَا رَيْبَ فِيهَا إِذْ يَتَنَزَّعُونَ مِنْهُمْ أَمْرَهُمْ فَقَالُوا ابْنُوا عَلَيْهِمْ بُنْيَانًا رَبُّهُمْ أَعْلَمُ بِهِمْ ؕ قَالَ الَّذِينَ غَلَبُوا عَلَىٰ أَمْرِهِمْ لَنَتَّخِذَنَّ عَلَيْهِمْ مَسْجِدًا
23. سَيُفْجَرُونَ تَلَّةً رَابِعُهُمْ كَلْبُهُمْ وَيَقُولُونَ خَمْسَةٌ سَادِسُهُمْ كَلْبُهُمْ رَجْمًا بِالْغَيْبِ ؕ وَيَقُولُونَ سَبْعَةٌ وَتَامَنَهُمْ كَلْبُهُمْ ؕ قُلْ رَبِّي أَعْلَمُ بِعَدَّتِهِمْ مَا يَعْلَمُهُمْ إِلَّا قَلِيلٌ ؕ فَلَمَّا نُمَارَ فِيهِمْ إِلَّا مِرَاءً ظَهْرًا وَلَا تَسْتَنْتَ فِيهِمْ مِنْهُمْ أَحَدًا
24. وَلَا تَقُولَنَّ لِيْشَأْنِي إِيَّايَ فَاعِلٌ ذَلِكَ غَدًا
25. إِلَّا أَنْ يَنْسَأَ اللَّهُ ؕ وَآذْكَرْ رَبِّكَ إِذَا نَسِيتَ وَقُلْ عَسَىٰ أَنْ يَهْدِيَنِّي رَبِّي لِأَقْرَبَ مِنْ هَذَا رَشَدًا
26. وَلَبِئُوا فِي كَهْفِهِمْ ثَلَاثَ مِائَةٍ سِنِينَ وَازْدَادُوا تِسْعًا

And here one English translation taken from [<http://www.al-islam.org/quran/>]

In the name of Allah, the Merciful, the Benevolent:

[9] *Or, do you think that the Fellows of the Cave and the Inscription were of Our wonderful signs?*

[10] *When the youths sought refuge in the cave, they said: Our Lord! grant us mercy from Thee, and provide for us a right course in our affair.*

[11] *So We prevented them from hearing in the cave for a number of years.*

[12] *Then We raised them up that We might know which of the two parties was best able to compute the time for which they remained.*

[13] *We relate to you their story with the truth; surely they were youths who believed in their Lord and We increased them in guidance.*

[14] *And We strengthened their hearts with patience, when they stood up and said: Our Lord is the Lord of the heavens and the earth; we will by no means call upon any god besides Him, for then indeed we should have said an extravagant thing.*

[15] *These our people have taken gods besides Him; why do they not produce any clear authority in their support? Who is then more unjust than he who forges a lie against Allah?*

[16] *And when you forsake them and what they worship save Allah, betake yourselves for refuge to the cave; your Lord will extend to you largely of His mercy and provide for you a profitable course in your affair.*

[17] *And you might see the sun when it rose, decline from their cave towards the right hand, and when it set, leave them behind on the left while they were in a wide space thereof. This is of the signs of Allah; whomsoever Allah guides, he is the rightly guided one, and whomsoever He causes to err, you shall not find for him any friend to lead (him) aright.*

[18] *And you might think them awake while they were asleep and We turned them about to the right and to the left, while their dog (lay) outstretching its paws at the entrance; if you looked at them you would certainly turn back from them in flight, and you would certainly be filled with awe because of them.*

[19] *And thus did We rouse them that they might question each other. A speaker among them said: How long have you tarried? They said: We have tarried for a day or a part of a day. (Others) said: Your Lord knows best how long you have tarried. Now send one of you with this silver (coin) of yours to the city, then let him see which of them has purest food, so let him bring you provision from it, and let him behave with gentleness, and by no means make your case known to any one:*

[20] For surely if they prevail against you they would stone you to death or force you back to their religion, and then you will never succeed.

[21] And thus did We make (men) to get knowledge of them that they might know that Allah's promise is true and that as for the hour there is no doubt about it. When they disputed among themselves about their affair and said: Erect an edifice over them-- their Lord best knows them. Those who prevailed in their affair said: We will certainly raise a masjid over them.

[22] (Some) say: (They are) three, the fourth of them being their dog; and (others) say: Five, the sixth of them being their dog, making conjectures at what is unknown; and (others yet) say: Seven, and the eighth of them is their dog. Say: My Lord best knows their number, none knows them but a few; therefore contend not in the matter of them but with an outward contention, and do not question concerning them any of them.

[23] And do not say of anything: Surely I will do it tomorrow,

[24] Unless Allah pleases; and remember your Lord when you forget and say: Maybe my Lord will guide me to a nearer course to the right than this.

[25] And they remained in their cave three hundred years and (some) add (another) nine.

The fact that number of verses in the story is 17 which is a prime number equals b^2+1 may also suggest that only triplets with prime b^2+1 can be used to generate some mathematical function to produce large prime numbers by extrapolating to larger and larger a, b, and c values.

A mathematician Iranian brother from the University of Pennsylvania, (Aminreza Abrahami Saba aminreza@seas.upenn.edu) saw more interesting properties to these simple numbers than first meets the eyes.

Assuming only the numbers 9, 25, 17 and 313 as per the story itself, then:

$$\begin{array}{rcl} 9x + 25y = 313 & \rightarrow & x = 7 \text{ and } y = 10 \\ 25 - 9 = 17 & = & x + y = 7 + 10 \end{array}$$

As nothing happens by coincident so maybe we should look at only such Pythagorean triplets where:

$$\begin{array}{rcl} a^2 \cdot x + c^2 \cdot y & = & \text{Prime Number} \\ c^2 - a^2 = x + y & = & \text{Prime Number} \end{array}$$

Also note that Pythagorean triplets can be multiplied by any factor to produce yet more triplets $(3,4,5) \times 2 = (6,8,10)$. Such non primitive triplets are most likely not useful and should therefore be filtered out.

A primitive Pythagorean triple (or PPT) is a triple of numbers $(a; b; c)$ so that a , b , and c have no common factors and satisfy the above $a^2 + b^2 = c^2$:

The following is Theorem taken from the lecture notes of Joseph Silverman of Brown University, Providence, USA

[<http://www.math.brown.edu/~jhs/frintch2ch3.pdf>]:

Theorem 2.1 (Pythagorean Triples Theorem). *You will get every primitive Pythagorean triple (a, b, c) with a odd and b even by using the formulas*

$$a = st, \quad b = \frac{s^2 - t^2}{2}, \quad c = \frac{s^2 + t^2}{2},$$

where $s > t \geq 1$ are chosen to be any odd integers with no common factors.

The first 14234 PPTs were generated for $t < 1000$ and $s < 1000$ and its graph was plotted for only the primitive Pythagorean triplets in that range where b^2+1 is prime. And sure enough, the graph looks very smooth and ready for extrapolation but as soon as a smaller range ($t < 100$ and $s < 100$) graph was plotted, the exponential function lost its smoothness.

This method is promising but needs more refining to be a good candidate for prime number generation and convincing mathematicians around the world that Quran is indeed the Word of God and it does contain the key to unlocking the mystery of the primes, if God permits.

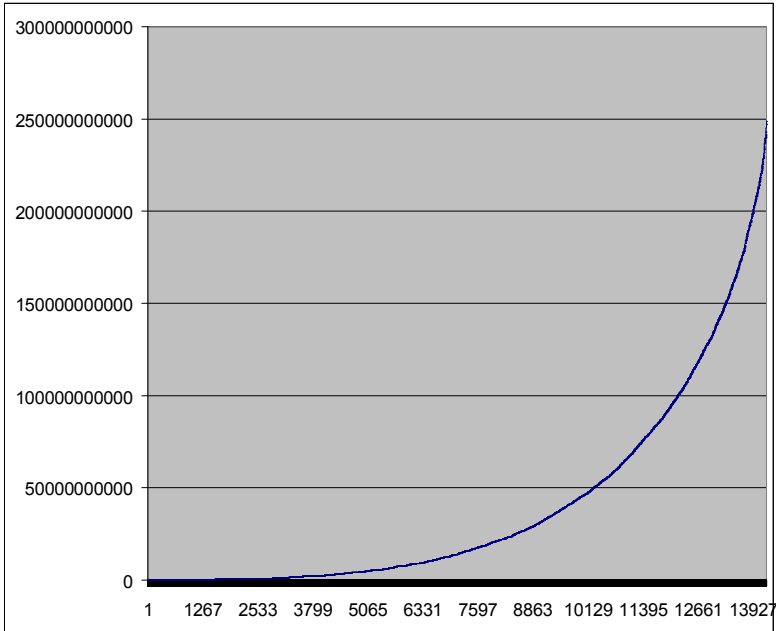

1000×1000 Primitive Pythagorean Triplets where b^2+1 is prime

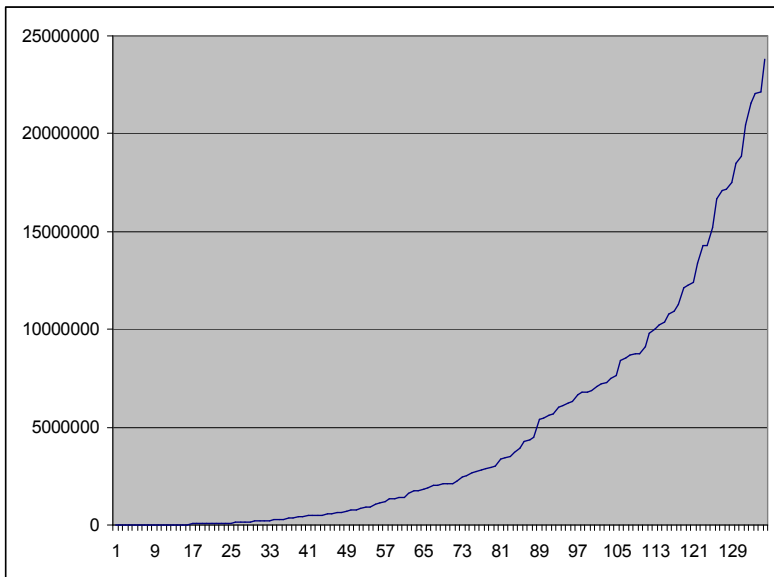

100×100 Primitive Pythagorean Triplets where b^2+1 is prime

God's Equation

The following Euler's Identity equation named after Leonhard Euler [http://en.wikipedia.org/wiki/Euler's_identity] incredibly unites the five most important values of mathematics; **1**, **0**, **π** , **e**, and **i**.

$$e^{i\pi} + 1 = 0$$

where:

e is Euler constant = $\sum (1 / n!) = 2.718281828459\dots$

i is the imaginary unit = $\sqrt{-1}$

π is circle circumference / diameter = **3.141592653589...**

This mystical union links representatives from each branch mathematics: arithmetic is represented by **0** and **1**, algebra by **i**, geometry by **π** , and analysis by the transcendental **e**.

This equation shows a deep relationship between the trigonometric functions and the complex exponential function and therefore sometimes called God's Equation. It can be readily derived from Euler's formula in complex analysis [http://en.wikipedia.org/wiki/Euler's_formula] as follows:

$$e^{ix} = \cos(x) + i \sin(x)$$

if **$x = \pi$** then

$$e^{i\pi} = \cos(\pi) + i \sin(\pi)$$

but **$\cos(\pi) = -1$**

and **$\sin(\pi) = 0$**

then:

$$e^{i\pi} = -1 + i \cdot 0$$

$$e^{i\pi} = -1$$

$$e^{i\pi} + 1 = 0$$

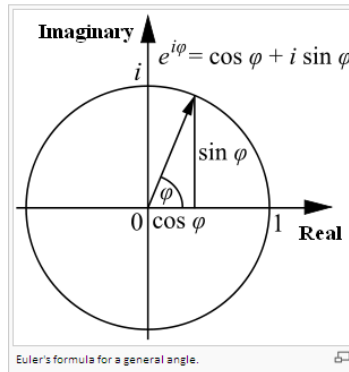

Carl Gauss, the Prince of Mathematics, once said that if one cannot immediately see that $e^{i\pi} + 1 = 0$, then he would never become a real mathematician ☺

The Golden Ratio

The diagram below shows a golden rectangle with a width to height such that whenever the largest square possible is cut out of it, the leftover shape remains a golden rectangle.

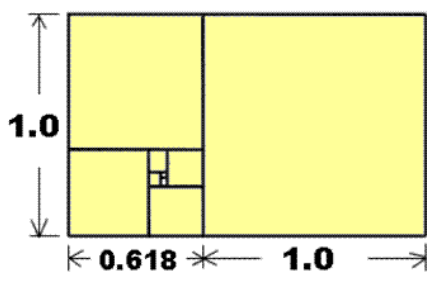

The Golden Rectangle

This golden rectangle is said to be the most *pleasing-to-the-eyes* rectangle

In mathematics, two quantities a and b are in golden ratio ϕ if the ratio of their sum to the larger quantity equals the ratio of the larger quantity to the smaller one [http://en.wikipedia.org/wiki/Golden_ratio].

For any $a > b$:

$$\phi = (a + b) / a = a / b$$

if b be the unit 1 then $\phi = a$ and thus:

$$(\phi + 1) / \phi = \phi / 1$$

$$\phi + 1 = \phi^2$$

$$\phi^2 - \phi - 1 = 0$$

solving the quadratic equation for ϕ we get:

$$\phi_1 = \frac{1 + \sqrt{5}}{2} = 1.618033988749...$$

$$\phi_2 = \frac{1 - \sqrt{5}}{2} = -0.618033988749...$$

Fibonacci Numbers

Fibonacci numbers [http://en.wikipedia.org/wiki/Fibonacci_number] is a sequence of numbers that start with 0 and 1 and each subsequent number in the series is the sum of the two numbers before it.

The first few numbers in the series are:

0, 1, 1, 2, 3, 5, 8, 13, 21, 34, 55, 89, 144, 233, 377, ...

[<http://www.mcs.surrey.ac.uk/Personal/R.Knott/Fibonacci/fibtable.html>].

Fibonacci numbers occur frequently in nature in such things as rabbits, cows and honeybees family trees, flower petals, sunflower seed heads, pine cones, seashell spirals, etc.

[<http://www.mcs.surrey.ac.uk/Personal/R.Knott/Fibonacci/fibnat.html>].

Fibonacci numbers can be drawn as rectangle of same areas as the number values as show here:

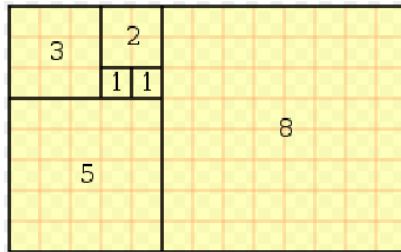

Fibonacci Rectangles

This diagram clearly shows a strong relationship between Fibonacci numbers and the golden ratio ϕ . Indeed, dividing any Fibonacci number by the one preceding it gives a ratio that is fluctuating around the golden ratio to smaller and smaller error margins as we go up the ladder of natural numbers.

Perfect Numbers

A number that is equal to the sum of all of its proper divisors (all divisors except itself) is called a *Perfect Number*. For example the number **28** has the following divisors: 1, 2, 4, 7, 14, and 28. Its proper divisors therefore are 1, 2, 4, 7, and 14. The sum of these divisors is $1+2+4+7+14 = 28$ which is the same as the value of the number itself.

The first few known perfect numbers are **6, 28, 496, 8128, 33550336**, etc. Every perfect number is a multiplication product of 2^{n-1} by a prime number of the form $2^n - 1$. Such prime numbers are called *Mersenne Primes*. Although not all $2^n - 1$ numbers are primes (e.g. $2^{11} - 1 = 2047 = 23 * 89$), all perfect numbers are related to Mersenne prime numbers by the above formula.

The following table lists all currently known perfect numbers (2009) taken from [<http://amicable.homepage.dk/perfect.htm>]:

#	Perfect Number	Digits	Discoverer
1	$2^1(2^2-1)$	1	?
2	$2^2(2^3-1)$	2	?
3	$2^4(2^5-1)$	3	?
4	$2^6(2^7-1)$	4	?
5	$2^{12}(2^{13}-1)$	8	1456 ?
6	$2^{16}(2^{17}-1)$	10	1588 Cataldi
7	$2^{18}(2^{19}-1)$	12	1588 Cataldi
8	$2^{30}(2^{31}-1)$	19	1772 Euler
9	$2^{60}(2^{61}-1)$	37	1883 Pervushin
10	$2^{88}(2^{89}-1)$	54	1911 Powers
11	$2^{106}(2^{107}-1)$	65	1914 Powers
12	$2^{126}(2^{127}-1)$	77	1876 Lucas
13	$2^{520}(2^{521}-1)$	314	1952 Robinson
14	$2^{606}(2^{607}-1)$	366	1952 Robinson
15	$2^{1278}(2^{1279}-1)$	770	1952 Robinson
16	$2^{2202}(2^{2203}-1)$	1327	1952 Robinson
17	$2^{2280}(2^{2281}-1)$	1373	1952 Robinson
18	$2^{3216}(2^{3217}-1)$	1937	1957 Riesel
19	$2^{4252}(2^{4253}-1)$	2561	1961 Hurwitz

20	$2^{4422} (2^{4423}-1)$	2663	1961 Hurwitz
21	$2^{9688} (2^{9689}-1)$	5834	1963 Gillies
22	$2^{9940} (2^{9941}-1)$	5985	1963 Gillies
23	$2^{11212} (2^{11213}-1)$	6751	1963 Gillies
24	$2^{19936} (2^{19937}-1)$	12003	1971 Tuckerman
25	$2^{21700} (2^{21701}-1)$	13066	1978 Noll & Nickel
26	$2^{23208} (2^{23209}-1)$	13973	1979 Noll
27	$2^{44496} (2^{44497}-1)$	26790	1979 Nelson & Slowinski
28	$2^{86242} (2^{86243}-1)$	51924	1982 Slowinski
29	$2^{110502} (2^{110503}-1)$	66530	1988 Colquitt & Welsh
30	$2^{132048} (2^{132049}-1)$	79502	1983 Slowinski
31	$2^{216090} (2^{216091}-1)$	130100	1985 Slowinski
32	$2^{756838} (2^{756839}-1)$	455663	1992 Slowinski & Gage
33	$2^{859432} (2^{859433}-1)$	517430	1994 Slowinski & Gage
34	$2^{1257786} (2^{1257787}-1)$	757263	1996 Slowinski & Gage
35	$2^{1398268} (2^{1398269}-1)$	841842	1996 Armengaud, Woltman, ...
36	$2^{2976220} (2^{2976221}-1)$	1791864	1997 Spence, Woltman, ...
37	$2^{3021376} (2^{3021377}-1)$	1819050	1998 Clarkson, Woltman, Kurowski, ...
38	$2^{6972592} (2^{6972593}-1)$	4197919	1999 Hajratwala, Woltman, Kurowski, ...
39	$2^{13466916} (2^{13466917}-1)$	8107892	2001 Cameron, Woltman, Kurowski, ...

Perfect Numbers and their Mersenne Primes

A revealing note about perfect numbers is that their binary representation is very symmetric of prime number P of 1s followed by $P-1$ of 0s as follows:

P	Perfect Number	Binary Representation
2	6	110
3	28	11100
5	496	111110000
7	8128	1111111000000
13	33550336	1111111111111000000000000
17	8589869056	11111111111111111000000000000000
19	137438691328	11111111111111111111100000000000000000

Binary Representation of Perfect Numbers

Circle within Circle

Carl Sagan's novel "Contact" [[http://en.wikipedia.org/wiki/Contact_\(novel\)](http://en.wikipedia.org/wiki/Contact_(novel))] ends as all great stories end, with a new beginning. In the last chapter 24 titled *The Artist's Signature* a revelation is shared with the reader of a signature of the Creator of the Universe found hidden thousands of places after the decimal point of the transcendental numbers π in base 11. Deep within its endless digits hides a perfect circle of ones immersed within a field of zeros in a square matrix.

Here is a slightly paraphrased ending from the book:

The program drew the digits in base 11 into a square matrix. The first line across is simply zeros. The second line showed a single one, exactly in the middle, with zeros to either side. After a few more lines, an unmistakable arc is formed, composed of ones. Line by line a perfect circle is traced out with ones in a background of zeros.

"The universe was made on purpose." the perfect circle says.

In whatever galaxy you find yourself, if you divide the circumference of a circle by its diameter and measure precisely enough, you would uncover the miracle—a circle drawing is hidden thousands of places after the decimal point of π .

There could be richer messages further in! ☺

Letter Frequency

Another area of further research is the study of letter frequencies of special phrases like “Bism Allah Ar-Rahmaan Ar-Raheem” and maybe even whole chapters and even the whole Quran itself.

Currently, I am developing a software application called “QuranCode 2012” to be used for all further research work God willing. Here is early prototype screenshot:

The screenshot shows the QuranCode 2012 application window. The title bar reads "QuranCode 2012". The main window is divided into several sections:

- Search Bar:** Contains the text "إبحث 0 / 0 ع ع".
- Left Panel:** A table showing letter frequencies for the opening verse. The header is "تكرار" (Repetition) and "حرف" (Letter). The data is as follows:

حرف	تكرار
ب	1
س	1
م	3
أ	3
ل	4
ه	1
ر	2
ح	2
ن	1
ي	1
- Center Panel:** Displays the opening verse: "بِسْمِ اللَّهِ الرَّحْمَنِ الرَّحِيمِ".
- Right Panel:** A list of words and their letter frequencies, numbered 1 to 38. The list is as follows:

1 الفاتحة	39 الزمر	77 المرسلات
2 البقرة	40 عاف	78 النبا
3 آل عمران	41 فصلت	79 النازعات
4 النساء	42 التثوري	80 عبس
5 المائدة	43 الزخرف	81 التکویر
6 الأنعام	44 الدخان	82 الانفطار
7 الأعراف	45 الجاثية	83 المحطفين
8 الأنفال	46 الأحقاف	84 الانتشاق
9 التوبة	47 محمد	85 البروج
10 بونس	48 القنق	86 الطارق
11 هود	49 الحمرات	87 الأعلى
12 يوسف	50 ق	88 العائنية
13 الرعد	51 الثاربات	89 الفجر
14 إبراهيم	52 الطور	90 البلد
15 الحجر	53 النجم	91 الشمس
16 النحل	54 القمر	92 الليل
17 الإسراء	55 الرحمن	93 الصحي
18 الكهف	56 الواقعة	94 النرح
19 مريم	57 الحديد	95 الدين
20 طه	58 المجادلة	96 الحلق
21 الأنبياء	59 الحنتر	97 القدر
22 الحج	60 الممتحنة	98 البينة
23 المؤمنون	61 الصف	99 الزلزلة
24 النور	62 الجمعة	100 العاديات
25 الفرقان	63 المنافقون	101 القارعة
26 الشعراء	64 التغابن	102 التكاثر
27 النمل	65 الطلاني	103 الحصر
28 القصص	66 التحريم	104 الهنرة
29 العنكبوت	67 الملك	105 الفيل
30 الروم	68 القلم	106 قريس
31 ثمان	69 الحاقة	107 الماعون
32 السجدة	70 المعارج	108 التکوثر
33 الأحزاب	71 نوح	109 الكافرون
34 سبا	72 الجن	110 النضر
35 فاطر	73 التزميل	111 الشمس
36 بس	74 المدثر	112 الإخلاص
37 الصافات	75 القنابة	113 العلق
38 ص	76 الإنسان	114 الناس
- Bottom Panel:** A status bar showing "1 سورة 7 آية 29 كلمة 139 حرف" and "Duaaright Ali Adams 2009".

QuranCode 2012 Screenshot for the Opening Verse of the Quran

Concatenating (right-to-left) the repetition counts of letters by their order of appearance in the opening verse of the Quran produced a prime number (1122143311) with the already prime number of letters in the verse a prime (19), producing an additive prime number. ☺

Verse	بِسْمِ اللَّهِ الرَّحْمَنِ الرَّحِيمِ									
Letter	ب	س	م	أ	ل	ه	ر	ح	ن	ي
Frequency	1	1	2	2	1	4	3	3	1	1
Right-to-Left	1122143311							Prime		
Digit Sum	1+1+2+2+1+4+3+3+1+1							19		
Prime Type	Additive Prime									

Letter Frequency of the Opening Verse

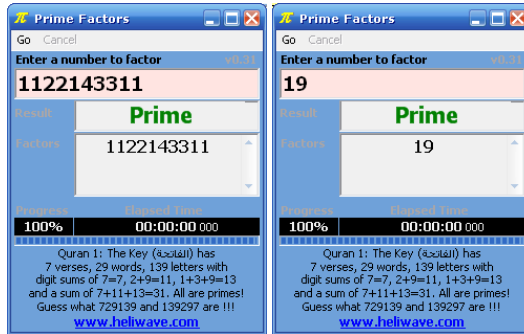

Prime Factorization of 1122143311 and 19

Here is a screenshot with letter frequencies for The Key chapter:

حرف تكرار	حرف	بسم الله الرحمن الرحيم	المرسلات 77	الزمر 39	الفاتحة 1
4	ب	أحمد لله رب العلمين	النبا 78	عافر 40	البقرة 2
3	س	الرحمن الرحيم	النارعات 79	فصلت 41	آل عمران 3
15	م	ملك يوم الدين	عس 80	التنوير 42	النساء 4
14	أ	إياك نعبد وإياك نستعين	التكوير 81	الزخرف 43	المائدة 5
22	ل	أهدنا الصراط المستقيم	الانفطار 82	الدخان 44	الأنعام 6
5	هـ	صراط الذين أنعمت عليهم ولا الضالين	المطففين 83	الحاشية 45	الأعراف 7
8	ر		الانشقاق 84	الأحقاف 46	الأنفال 8
5	ح		المروج 85	محمد 47	التوبة 9
11	ن		الطارق 86	القنق 48	يونس 10
14	ي		الأعلى 87	الحجرات 49	هود 11
4	د		العافية 88	قي 50	يوسف 12
6	ع		الفجر 89	الذاريات 51	الرعد 13
3	ك		البند 90	الطور 52	إبراهيم 14
4	و		التينس 91	النجم 53	الحجر 15
2	ل		الليل 92	القمر 54	الشح 16
5	أ		الضحى 93	الرحمن 55	الإسراء 17
3	ت		التبرج 94	الواقعة 56	الكهف 18
2	ص		التين 95	الحديد 57	مريم 19
2	ط		العلق 96	المجادلة 58	طه 20
1	ق		القدر 97	الأنبياء 59	الأنبياء 21
1	ذ		البينة 98	المنمحنة 60	الحج 22
2	غ		الزلزلة 99	الصف 61	المؤمنون 23
2	ض		العاديات 100	الجمعة 62	النور 24
			القارعة 101	المنافقون 63	الفرقان 25
			التكاثر 102	التعاني 64	التسعراء 26
			العصر 103	الطلاق 65	النمل 27
			التهمة 104	التحریم 66	القصاص 28
			الفيل 105	الملك 67	العنكبوت 29
			قريس 106	القنق 68	الروم 30
			الماعون 107	الحاقة 69	لقمان 31
			الكوثر 108	المعارج 70	السجدة 32
			الكاغرون 109	نوح 71	الأحزاب 33
			النصر 110	الجن 72	سبا 34
			المسد 111	المرمل 73	فاطر 35
			الإخلاء 112	المدثر 74	يس 36
			العلق 113	القيامة 75	الصافات 37
			الناس 114	الإنسان 76	ص 38

QuranCode 2012 Screenshot for The Key chapter of the Quran

Concatenating (left-to-right or right-to-left) the repetition counts of letters of The Key chapter produced a non-prime composite numbers:

$$22112234364141158522221534 = 2 * 13 * 13 * 21277409 * 3074660628473527$$

$$43152222585111446343221122 = 2 * 113 * 283 * 674696247304660032259$$

This suggests that something else could be hidden behind these concatenated numbers and Allah knows best.

Here is a screenshot with letter frequencies for the semi-simplified text (37 letters) of the Holy Quran in with search matches highlighted in red.

QuranCode 2012

إبحث 2814 / 1 ع ع

حرف تكرار

ب	11603
س	6122
م	27071
أ	13819
ل	38550
ه	14962
ر	12627
ح	4364
ن	27380
ي	18334
د	5991
ع	9405
ك	10497
و	24970
إ	5088
أ	25184
ت	10520
ص	2074
ط	1273
ق	7034
ذ	4932
أ	8901
غ	1221
ض	1886
ف	8747
ي	6605
ؤ	706
ة	2344
ز	1599
ء	3059
خ	2497
ئ	1416
ش	2124
ظ	853
ج	3317
ث	1414
328289	

بِسْمِ اللَّهِ الرَّحْمَنِ الرَّحِيمِ
 أَحْمَدُ لِلَّهِ رَبِّ الْعَالَمِينَ
 الرَّحْمَنِ الرَّحِيمِ
 مَلِكُ يَوْمِ الدِّينِ
 إِيَّاكَ نَعْبُدُ وَإِيَّاكَ نَسْتَعِينُ
 أَهْدِنَا الصِّرَاطَ الْمُسْتَقِيمَ
 صِرَاطَ الَّذِينَ أَنْعَمْتَ عَلَيْهِمْ غَيْرِ
 الْمَغضُوبِ عَلَيْهِمْ وَلَا الضَّالِّينَ
 بِسْمِ اللَّهِ الرَّحْمَنِ الرَّحِيمِ
 ذَلِكَ الْكِتَابُ لَا رَيْبَ فِيهِ هُدًى لِّلْمُتَّقِينَ
 الَّذِينَ يُؤْمِنُونَ بِالْغَيْبِ وَيُقِيمُونَ الصَّلَاةَ
 وَمِمَّا رَزَقْنَاهُمْ يُنْفِقُونَ
 وَالَّذِينَ يُؤْمِنُونَ بِمَا أُنزِلَ إِلَيْكَ وَمَا
 أُنزِلَ مِنْ قَبْلِكَ وَيَأْتِ الْآخِرَةَ هُمْ يُوقِنُونَ
 أُولَئِكَ عَلَى هُدًى مِنْ رَبِّهِمْ وَأُولَئِكَ هُمُ
 الْمُفْلِحُونَ
 إِنَّ الَّذِينَ كَفَرُوا سَوَاءٌ عَلَيْهِمْ ءَأَنْذَرْتَهُمْ
 أَمْ لَمْ تُنذِرْهُمْ لَا يُؤْمِنُونَ
 خَتَمَ اللَّهُ عَلَى قُلُوبِهِمْ وَعَلَى سَمْعِهِمْ
 وَعَلَى أَبْصَارِهِمْ غِشَاةً وَلَهُمْ عَذَابٌ
 عَظِيمٌ
 وَمَنْ النَّاسُ مِنْ يَقُولُ ءَامَنَّا بِاللَّهِ وَبِآلِيهِمْ
 أَلْءَاخِرِ وَمَا هُمْ بِمُؤْمِنِينَ
 يَخْذَعُونَ لِلَّهِ وَالَّذِينَ ءَامَنُوا وَمَا

المرسلات	77	الزمر	39	الفاتحة	1
النبا	78	عافر	40	البقرة	2
التارعات	79	فصلت	41	أل عمران	3
عيس	80	النشور	42	النساء	4
التكوير	81	الزخرف	43	المائدة	5
الانفطار	82	الدخان	44	الأنعام	6
المطففين	83	الجانثية	45	الأعراف	7
الانشقاق	84	الأحقاف	46	الأنفال	8
البروج	85	محمد	47	التوبة	9
الطارق	86	الفتح	48	يونس	10
الأعلى	87	الحجرات	49	هود	11
الغاشية	88	ق	50	يوسف	12
الفجر	89	الذاريات	51	الرعد	13
البلد	90	التطور	52	إبراهيم	14
الشمس	91	النجم	53	الحجر	15
الليل	92	القمر	54	التحتل	16
الضحى	93	الرحمن	55	الإسراء	17
الشرح	94	الواقعة	56	التكليف	18
التين	95	الحديد	57	مريم	19
العنق	96	المجادلة	58	طه	20
القدر	97	الحشر	59	الأنبياء	21
البينة	98	الممتحنة	60	الحج	22
الزلزلة	99	الصف	61	المؤمنون	23
العاديات	100	الجمعة	62	النور	24
القارعة	101	المنافقون	63	الفرقان	25
التكاثر	102	التغابن	64	التسماء	26
النصر	103	الطلاق	65	النمل	27
الهمزة	104	التحریم	66	القصاص	28
الفيل	105	الملك	67	التكويث	29
قربس	106	الفتح	68	الروم	30
الماعون	107	الحاقة	69	لقمان	31
الكوثر	108	المعارج	70	السجدة	32
الكاغرون	109	نوح	71	الأحزاب	33
النصر	110	الحن	72	سبا	34
المسد	111	الزمر	73	فاطر	35
الإخلاص	112	المدثر	74	س	36
الفلق	113	القيامه	75	الصفافات	37
الناس	114	الإنسان	76	ص	38

حرف 328289 كلمة 77878 آية 6236 سورة All

QuranCode 2012 Screenshot for the semi-simplified Quranic Text

No attempt was made to test the right-to-left concatenated long number (...612211603) for primality. Of course left-to-right concatenation (...85333171414) produces an even number other than 2 so it is composite

And finally here is a screenshot with letter frequencies for the fully-simplified text (29 letters) of the Holy Quran with search matches highlighted in red and all letters drawn in gray shades according to their Primology Values.



QuranCode 2012 Screenshot for the fully-simplified Quranic Text

Pictures and Animations

A further research effort will try to discover the best arrangement for a picture of the Quran where all words (or letters) are grayed proportionally to their PV values and then arranged together within a Golden Rectangle to reveal possible visual messages.

Simplified Letters				Simplified Words			
Full Quran				Full Quran			
77878				328289			
219.39	354.98			450.44	728.82		
Message with bismAllah				Message with bismAllah			
77849		29			328150		139
219.35	354.91	words			450.34	728.67	letters
Message without bismAllah				Message without bismAllah			
77401		448	112	4	326022		2128 112 19
218.72	353.89	bisms words		448.88 726.30		bisms letters	

Complex Letters				Complex Words			
Full Quran				Full Quran			
82456				632137			
225.74	365.26			625.05	1011.35		
Message with bismAllah				Message with bismAllah			
82427		29			631998		139
225.70	365.20	words			624.98	1011.23	letters
Message without bismAllah				Message without bismAllah			
81979		448	112	4	628078		3920 112 35
225.09	364.20	bisms words		623.04 1008.09		bisms letters	

Finally, since chapter #36 YaSeen (يس) is called the *Heart of The Quran* and since it consists of 729 words ($3 \times 3 \times 3 \times 3 \times 3$), a further research effort will try to arrange the words as dots grayed proportionally to their PV values in a 3D cube of $9 \times 9 \times 9$ or an animated GIF picture of 9 layers of 9×9 pixel each to see if indeed a heart shape might be hidden within the chapter itself as its signature. ☺

If this does not produce a positive result then we could try similar processes on the 3039 (= 3×1013) letters of the chapter itself.

Conclusions

Other research efforts pursue a single number like 7 or 19 and try their best to massage the Quranic data to fit desired outcomes. This work first a proper research methodology for itself and for others to enhance and strictly follow in order to unlock some secret knowledge hidden deep within the message of the Quran, with God's permission.

The goal of this research is 1) to confirm the consistency of the Quran and 2) to extract new knowledge from it including future knowledge that Allah permits the believers to gain in order to prepare ourselves for future events.

This research can also answer those who do not believe in the Message of Allah by witnessing predicted events unfold before their own eyes and finally submit to the Will of Allah Almighty as the only Creator and Sustainer of all Seen and Unseen worlds in real-time, all the time.

Thanks to Allah, a key to decode the Message of the Quran has been found within its first chapter that is appropriately named *The Key* or *The Opener* (الفتاحة) that consists of 7 verses, 29 words, and 139 letters. All these numbers are prime numbers that also have prime digit sums, a specific type of primes called *Additive Primes*.

As a result of this finding, a new numerology system called "*Primalogy*" was developed and applied to the 139 letters of The Key chapter and amazingly produced a total primalogy value that is also an additive prime (8317 | 19).

Further research revealed that the 114 chapters of the Quran and their 6236 verses are in fact two separate parts. A Key part that consists of *The Key* chapter only with its 7 verses, and a Message part that consists of the remaining 113 chapters and their 6229 verses. All these number (1, 7, 113, 6229) are additive primes too.

This research has undeniably proved the following:

1. The Key chapter is the key to decoding the Message of the Quran; the remaining 113 chapters,
2. The "Bism Allah Ar-Rahmaan Ar-Raheem" of The Key (الفتاحة) chapter is not a prefix but an integral part of it as verse #1. Therefore this opening verse of the Quran is mandatory and must be recited with its chapter at all times unlike the prefix in the Oneness of God (الإخلاص) chapter.

3. The widely used recitation method of Hafs (حفص) is the correct method and all others are possibly noise and distortion to the Word of Allah but only God knows why they exist. To test us perhaps!
4. The oft-repeated verse of The Merciful (الرحمن) chapter

أعوذ بالله من الشيطان الرجيم بسم الله الرحمن الرحيم

”فَبِأَيِّ آءَالَاءِ رَبِّكُمَا تُكَذِّبَانِ“

“What other bounties of your Sustainer do you still belie?”

conceals behind it an additive prime (1433 | 11) that was shown to point to the Islamic lunar year **1433AH** which maps to **2012AD** for Allah has made the number of words in this chapter the same as the number of days in this lunar year (**355** words for **355** days).

5. One-to-one mapping of words to days revealed that the first occurrence of this verse will start on **7th January 2012** and the last occurrence will end on **7th November 2012**, God willing.
6. More research revealed yet another additive prime number (1619 | 17) that points to the Islamic lunar year future date of **1619AH** which maps to **2192AD**.
7. This 180-year gap (2012 – 2192) proves that 2012 will not be the End of the World but hopefully a new and real **Spiritual Awakening** by all humanity. It is only Allah who decides when the End of the World will come and it can be at the blink of an eye or even nearer according to Quran 16:77:

أعوذ بالله من الشيطان الرجيم بسم الله الرحمن الرحيم

وَاللَّهُ غَيْبُ السَّمَوَاتِ وَالْأَرْضِ وَمَا أَمْرُ السَّاعَةِ إِلَّا كَلَمْحِ الْبَصَرِ أَوْ هُوَ أَقْرَبُ إِنَّ اللَّهَ عَلَىٰ كُلِّ شَيْءٍ قَدِيرٌ

“To Allah belongs the Unseen of heavens and earth and The Hour can come at the blink of an eye, or even nearer. Truly! Allah is capable of doing anything.”

وَالْحَمْدُ لِلَّهِ رَبِّ الْعَالَمِينَ

Glory to Allah the Sustainer of all worlds, the Seen and Unseen.

Further Thoughts

All praise and exaltation is due to God, the Creator and Sustainer of all Seen and Unseen worlds of man (clay-based), jinn (fire-based), angel (light-based), and all that is unknown.

This part of the book will take the reader on a spiritual journey to uncover the true meanings behind difficult to understand concepts such as Soul and Spirit, No Power but that of God, Dreaming and Visions, Death and Returning to God, Freewill and Predestination, Nuclear Fusion in the Quran, Helical Particle Waves.

Within a few pages you shall be empowered with new knowledge that Allah has revealed that will change the way you look at world around you, forever. Suddenly, all random thoughts you may have accumulated over the years will fit together into a coherent knowledge that will cleanse your soul and give your prayers a new taste and real feeling that you are communicating with your Creator, Allah Almighty.

Imam Ali bin abi Talib (peace be upon him) said:

"God created Angel with reasoning power but with neither desire nor anger, created Animal with desire and anger but without reasoning power, and created Man with all three.

So if Man allows desire or anger to control his reasoning power he becomes worse than an animal, and if he controls his desire and anger with reasoning power he becomes better than an angel."

We, normal people, all exhibit a mixture of angelic and animalistic behavior and therefore should try to maximize the former and minimize the latter with the grace of Allah, as deeds are counted by intentions not by results.

Make sure your intentions are always for the sake of pleasing your Creator not yourself and He will make you enjoy it more than if you intended it for yourself alone. Even the simple act of helping should be exclusively done to please Allah who will give you back in this world through a different channel as all deeds go in circles of π . ☺

Get ready to ride the wave of spiritual awakening.

Bigger than Infinity

In a wonderful book "*The Story of Faith: Philosophy, Science, and Quran*" (قصة الإيمان: بين الفلسفة والعلم والقرآن) by Nadeem Al-Jisr (نديم الجسر), the reader is taken through a hypothetical discussion between philosophers arguing among themselves as to the nature of God Almighty as follows:

"If we were created by our parents and they were created in turn by theirs and so on, then who created the original creator? And even if we found out who the original creator is, then who created it?"

They quickly concluded that such a question is a closed question and takes them no where, and instead they devised a new cleverer question which goes like that:

"What are the attributes of an entity that creates things but it does not need to be created?"

They pondered on the question and listed the following attributes:

- It must be one, the root for every creation.
- It must be alive to be able to think and decide to create.
- It must have the power (*Omnipotent*) to create.
- It must encompass everything it creates (*Omnipresent*).
- It must be aware of the state of all its creations (*Omniscient*).

They were in fact describing **God** without realizing. And when you realize that the word "Allah" has no gender in Arabic, then all fits perfectly because Allah Almighty, the Omnipotent, Omnipresent and Omniscience is neither a male nor a female and nothing compares to **IT**.

As the Arabic language lacks the pronoun "it" and uses "he" or "she" for everything, animate (living) or inanimate (non-living) and the English language use "it" for the inanimate, I decided to coin a new form of the "it" as "**IT**" with all letters capital regardless where it appears in the sentence.

Therefore **IT** is the Creator is the root of all creation that was not created and the Arabic phrase **Allah Akbar** (الله أكبر) literally means **Allah is bigger**, not "biggest", "great", "greater" or "greatest" because the incomplete sentence of "*Allah is bigger*" raises curiosity by the reader/listener as to bigger than what?

Well **IT** is bigger than anything you they can think of, even bigger than the mathematically unreachable infinity (∞).

Five Domains

In mathematics a point has zero dimensions while a line made up of an infinite number of points has a single dimension. How we add up infinite zeros and get a something bigger than zero is beyond me.

In physics however, and in string theory in particular [www.superstringtheory.com], a point is the smallest physically possible cube with sides of *Planck Length* (1.6×10^{-35} m), the smallest possible length in nature or the natural length unit as proposed by the Max Planck in 1899 [http://en.wikipedia.org/wiki/Planck_units].

Inside such a point there exists a world of vibrating energy strings (or quanta) with seven extra dimensions beyond the common X, Y, Z and time.

Although the number of combinations of values for these 11 dimensions exceeds 10^{500} , String theorists were expecting one magical combination for the underlying structure of nature. Instead they ended up with five unique solutions each valid enough for an independent existence and capable of keeping a point existent and stable in its own type of world. Each solution says: "*I am the one, I am reality*".

Little they know reality is in fact all these five different domains or realms as listed here:

1. **Man domain**, for our material world,
2. **Dream domain**, for our souls during sleep (mini-death),
3. **Barzakh domain** (البرزخ) for our souls during full-death as an intermediate station between this lower-reality life (test) and the real life of the hereafter,
4. **Jinn domain**, for jinn plasma (fire) world, and
5. **Angel domain**, for angel spiritual world.

In order to teleport from one domain to another one must gain the energy difference to be able to vibrate at their frequency (what is hypnotized by the Sci-Fi series Star Trek as *Cloaking*. ☺)

Allah Almighty says in Quran 7:26–27:

أَعُوذُ بِاللَّهِ مِنَ الشَّيْطَانِ الرَّجِيمِ بِسْمِ اللَّهِ الرَّحْمَنِ الرَّحِيمِ

يٰٓبَنِي ۤأَدَمَ قَدْ أَنْزَلْنَا عَلَيْكُمْ لِبَاسًا يُورِي سَوْءَكُمْ وَرَيْنَابًا وَرِيۤسًا ۗ وَلِبَاسُ التَّقْوَىٰ ذَٰلِكَ خَيْرٌ ۗ ذَٰلِكَ مِّنْ ءَايَاتِ اللَّهِ لَعَلَّهُمْ يَذَّكَّرُونَ

“O children of Adam, we have provided you with garments to cover your bodies, as well as for luxury. But the righteous garment is the best of garments. These are some of Allah's signs, that they may take heed.”

يٰٓبَنِي ۤأَدَمَ لَا يَفْتِنَنَّكُمُ الشَّيْطَانُ ۖ كَمَا أَخْرَجَ أَبَوَيْكُم مِّنَ الْجَنَّةِ يَنزِعُ عَنْهُمَا لِبَاسَهُمَا لِيُرِيَهُمَا سَوْءَهُمَا ۗ إِنَّهُ يَرَىٰكُمْ هُوَ وَقَبِيلُهُ مِمَّنْ حَبَّبَ لَمْ يَرَوْهُمْ إِلَّا جَعَلْنَا الشَّيَاطِينَ أَوْلِيَاءَ لِلَّذِينَ لَا يُؤْمِنُونَ

“O children of Adam, do not let the devil dupe you as he did when he caused the eviction of your parents from Paradise, and the removal of their righteous garments to expose their bodies. He and his tribe see you, while you do not see them. We appoint the devils as companions of those who do not believe.”

These two verse show that the *righteous garment* (لِبَاسُ التَّقْوَىٰ) could be a shield with a higher energy level that the Satan and his followers cannot attain to cross into our domain.

Anyone who does not believe in Allah, His angels or the Unseen world would have his/her shield lowered to such a low energy level that the Satan and his followers can bypass their shield at will without the disbeliever knowledge or permission. No *righteous garment* for such a non-righteous person.

Body, Soul, and Spirit

The Prophet (pbuh+f) was once asked about the nature of the Spirit (الروح) so Allah Almighty revealed to him the following verse in Quran 17:85:

أعوذ بالله من الشيطان الرجيم بسم الله الرحمن الرحيم

وَيَسْأَلُونَكَ عَنِ الرُّوحِ قُلِ الرُّوحُ مِنْ أَمْرِ رَبِّي وَمَا أُوتِيتُمْ مِنَ الْعِلْمِ إِلَّا قَلِيلًا

*They are asking thee concerning the **Spirit**. Say: The Spirit is by command of my Lord, and of knowledge ye have been given but little.*

Allah Almighty confirms here that only He knows the nature of Spirit and no one else, not even the Prophet, is afforded such knowledge for a reason we will only perhaps know when we are resurrected on Judgment Day as stated in Quran 50:20–22:

أعوذ بالله من الشيطان الرجيم بسم الله الرحمن الرحيم

20. وَتُفْخِ فِي الصُّورِ ذَٰلِكَ يَوْمَ الْوَعِيدِ

And the trumpet is blown. This is the threatened Day (Judgment Day).

21. وَجَاءَتْ كُلُّ نَفْسٍ مَعَهَا سَائِقٌ وَشَهِيدٌ

*And there will come forth every **soul**: with each will be an (angel) to drive, and an (angel) to bear witness.*

22. لَقَدْ كُنْتُمْ فِي غَفْلَةٍ مِّنْ هَٰذَا فَكَشَفْنَا عَنْكَ غِطَاءَكَ فَبَصَرُكَ الْيَوْمَ حَدِيدٌ

*Certainly you were heedless of this, and now We have removed your veil, so **your sight today is as strong as iron.***

So when Allah Almighty says in Quran 36:36:

أعوذ بالله من الشيطان الرجيم بسم الله الرحمن الرحيم

سُبْحٰنَ الَّذِي خَلَقَ الْأَزْوَاجَ كُلَّهَا مِمَّا تُنْبِتُ الْأَرْضُ وَمِنْ أَنفُسِهِمْ وَمِمَّا لَا يَعْلَمُونَ

Glory be to Him Who created all the sexual pairs, of that which the earth grows, and of themselves, and of that which they know not!

Then it is perhaps better to explain this verse as:

*“Glory to the One who created ALL sexual pairs out of three things; **Body** grown out of earthly material (Quran 71:17), their **Souls** (Quran 4:1), and the already told about unknown **Spirit** (Quran 17:85).”*

[Interpreted by Ali Adams.]

As oppose to the standard interpretation of:

“Glory to the One who created all couples such as what the earth grows (plants), and their souls (human and animal), and what you do not know (living forms still to be discovered).”

Here is what Allah Almighty says in Quran 71:17:

أعوذ بالله من الشيطان الرجيم بِسْمِ اللَّهِ الرَّحْمَنِ الرَّحِيمِ

وَأَلَلَّهُ أَنْبَتَكُمْ مِّنَ الْأَرْضِ نَبَاتًا

*And Allah has **grown you** from the earth growing (gradually)*

and in Quran 4:1:

أعوذ بالله من الشيطان الرجيم بِسْمِ اللَّهِ الرَّحْمَنِ الرَّحِيمِ

يَا أَيُّهَا النَّاسُ اتَّقُوا رَبَّكُمُ الَّذِي خَلَقَكُمْ مِّنْ نَفْسٍ وَاحِدَةٍ وَخَلَقَ مِنْهَا زَوْجَهَا وَبَثَّ مِنْهُمَا رِجَالًا كَثِيرًا وَنِسَاءً ۗ وَاتَّقُوا اللَّهَ الَّذِي تَسَاءَلُونَ بِهِ وَاللَّارْحَامَ ۚ إِنَّ اللَّهَ كَانَ عَلَيْكُمْ رَقِيبًا
*O mankind! Be careful of your duty to your Lord Who created you from a **single soul** and from it created its mate and from them twain hath spread abroad a multitude of men and women. Be careful of your duty toward Allah in Whom ye claim (your rights) of one another, and toward the wombs (that bare you). Lo! Allah hath been a watcher over you.*

and in Quran 3:25:

أعوذ بالله من الشيطان الرجيم بِسْمِ اللَّهِ الرَّحْمَنِ الرَّحِيمِ

فَكَيْفَ إِذَا جَمَعْتَهُمْ لِيَوْمٍ لَا رَيْبَ فِيهِ وُوقِيَتْ كُلُّ نَفْسٍ مَّا كَسَبَتْ وَهُمْ لَا يُظْلَمُونَ
*Then how will it be when We shall gather them together on a Day about which there is no doubt, and every **soul** shall be fully paid what it has earned, and they shall not be dealt with unjustly?*

and in Quran 12:53:

أعوذ بالله من الشيطان الرجيم بِسْمِ اللَّهِ الرَّحْمَنِ الرَّحِيمِ

وَمَا أُبْرِئُ نَفْسِي ۚ إِنَّ النَّفْسَ لَأَمَّارَةٌ بِالسُّوءِ ۗ إِلَّا مَا رَحِمَ رَبِّي ۚ إِنَّ رَبِّي غَفُورٌ رَّحِيمٌ
*Nor do I absolve myself (of blame): the (human) **soul** is certainly prone to evil, except that which my Lord has bestowed His Mercy upon. Indeed my Lord is Oft-forgiving, Most Merciful.*

and in Quran 75:2:

أعوذ بالله من الشيطان الرجيم بِسْمِ اللَّهِ الرَّحْمَنِ الرَّحِيمِ

وَلَا أَقْسِمُ بِالنَّفْسِ اللَّوَّامَةِ

*Nay, I swear by the **self-accusing soul** (that this Scripture is true*

and in Quran 89:27:

أعوذ بالله من الشيطان الرجيم بِسْمِ اللَّهِ الرَّحْمَنِ الرَّحِيمِ

يَا أَيُّهَا النَّفْسُ الْمُطْمَئِنَّةُ

*O (thou) **soul**, in (complete) peace and assurance of safety!*

and in Quran 91:7–10:

أعوذ بالله من الشيطان الرجيم بسم الله الرحمن الرحيم

And a soul and Him Who perfected it	7. وَنَفْسٍ وَمَا سَوَّاهَا
And taught it what is wrong and what right for it.	8. فَأَلَّهَمَهَا فُجُورَهَا وَتَقْوَاهَا
He is indeed successful who purifies it,	9. قَدْ أَفْلَحَ مَنْ زَكَّاهَا
And he will indeed fail who corrupts it.	10. وَقَدْ خَابَ مَنْ دَسَّاهَا

So what is the difference between Soul (النفس) and Spirit (الروح)?

I can only answer this fundamental question by first explaining the meaning of a phrase used by Muslims very often as a cliché without comprehending its real meaning which is:

لا حولَ ولا قوةَ إلا بالله

“No power to change or force to enact except that of Allah”

The fundamental meaning of this phrase can be thought of that God Almighty is continuously sustaining all life forms with His energy to exist. After all, God describes Himself as the Sustainer of all worlds (رَبُّ الْعَالَمِينَ) and not just a passive creator who creates and then watches his creation from the outside and only intervenes if needed, no never. Allah is with us and powers us all the time in real-time.

In order to comprehend this, we need to consider the human being as made of three complementary parts that co-exist albeit in different realities or domains:

- body (الجسد) (like computer hardware or a body of a car)
- soul (النفس) (like computer software or a car driver)
- spirit (الروح) (like electricity or fuel in a car)

Whereas the **body** is an executive tool to carry out what the soul desires (its will) that exists in our physical domain only, the **soul** is one's self and has its desire, anger and reasoning power (العقل) to differentiate between good and evil, the **soul** acts as a bridge between the physical and the spiritual domains but not at the same time as it moves continuously back and forth between them at very high frequency.

The **spirit** on the other hand is only known to Allah All-knowing as stated in Quran 17:84 (above). However, one of its functions is to keep the body alive as per Quran 39:42 (below) by channelling Allah's energy to it on demand.

The interworking of the three interconnected entities may be described as follows but only Allah knows the truth:

When the soul desires the body to do something (e.g. move, speak, breath, think, sleep, etc.), it must first consult the spirit for what the consequences are, both rewards and punishments, and awaits the spirit reply that will come almost instantly. The soul can then *either* acknowledge the consequences and ask for the exact required energy to be channelled to the body *or* decline and go to the next desire, and so on.

The communication is instantaneous and is faster than anything we can think of, even the speed of light. This process is continuous but we do not realize in the same way after we become accustomed to background noise or smell. Every time this process takes place, the soul signs its acknowledgement in a book that is to be shown to us on Judgment Day as per Quran 18:49:

أَعُوذُ بِاللَّهِ مِنَ الشَّيْطَانِ الرَّجِيمِ بِسْمِ اللَّهِ الرَّحْمَنِ الرَّحِيمِ

وَوَضِعَ الْكِتَابَ فَتَرَى الْمُجْرِمِينَ مَشْفِقِينَ مِمَّا فِيهِ وَيَقُولُونَ يَا وَيْلَتَنَا مَا لَ هَذَا الْكِتَابِ لَا يُغَادِرُ صَغِيرَةً وَلَا كَبِيرَةً إِلَّا أَحْصَىٰهَا وَوَجَدُوا مَا عَمِلُوا حَاضِرًا وَلَا يَظْلِمُ رَبُّكَ أَحَدًا

And the Book shall be placed, then you will see the guilty fearing from what is recorded in it, and they will say: Ah! woe to us! what a book is this! it does not leave out neither a small nor a great thing but counts them; and whatever deeds they had done they shall find present in front of them; and your Lord does not deal unjustly with anyone.

So, whereas the spirit acts like a guardian angel entrusted with the job of keeping the body alive by channeling energy on soul requests and keeping track of all of its deeds, the soul bears full responsibility and in the hereafter will be bear the fruit of its labour in this life, and thus be rewarded with Hell or Paradise justly.

A final thought to help appreciate and feel this concept on a daily basis is that, one needs to always think of Allah as transcendent existing everywhere at once and is the only source of energy that is continuously sustaining all life in all Seen and Unseen domains in real-time, all the time.

GOD is ONE, AWARE, TIMELESS, BOUNDLESS, EVERYWHERE AT ONCE, CREATOR & SUSTAINER of EVERYTHING, and KNOWS ALL.

God is Allah who is:

- **Omnipotent** (Almighty, having infinite power),
- **Omnipresent** (present everywhere at all times), and

- **Omniscient** (having infinite knowledge).

Dreams and Visions

Allah says in Quran 39:42

أَعُوذُ بِاللَّهِ مِنَ الشَّيْطَانِ الرَّجِيمِ بِسْمِ اللَّهِ الرَّحْمَنِ الرَّحِيمِ

اللَّهُ يَتَوَفَّى الْأَنفُسَ حِينَ مَوْتِهَا وَالَّتِي لَمْ تَمُتْ فِي مَنَامِهَا فَيُمْسِكُ الَّتِي قَضَىٰ عَلَيْهَا
الْمَوْتَ وَيُرْسِلُ الْأُخْرَىٰ إِلَىٰ أَجَلٍ مُّسَمًّى ۚ إِنَّ فِي ذَٰلِكَ لَآيَاتٍ لِّقَوْمٍ يُتَفَكَّرُونَ

Allah returns to Him the souls when dying or during their sleep; then He withholds those on whom He has passed the decree of death and sends the others back till an appointed term. Most surely there are signs in this for those who reflect.

This verse shows that when one sleeps his soul (النفس) leaves his body and enters dreamland while his spirit (الروح) keeps his body alive because one of it functions is an energy gate to Allah, the energy Provider.

Any soul that is to die while asleep, not only its does not come back to the body but its corresponding spirit leaves the body too. Other souls come back into their bodies to wake them up from possibly their *Rapid Eye Movement* sleep state and back to this material world or domain.

If a soul is pure enough, it will remember what it has been allowed to see including future events in dreamland. Other less pure souls would suffer from interference from the Satan and his followers who corrupt their dreams or even worst reverse them.

This is why dreams of the Prophets are real visions into the future (رُءْيَا) and must therefore be acted upon, while average people like you and I only remember distorted facts which is why many books written about dreams assume impure souls and thus try to interpret dreams inversely, and Allah knows best.

Death versus Returning to God

Allah All-knowing says in Quran 2:154:

أَعُوذُ بِاللَّهِ مِنَ الشَّيْطَانِ الرَّجِيمِ بِسْمِ اللَّهِ الرَّحْمَنِ الرَّحِيمِ

وَلَا تَقُولُوا لِمَنْ يُقْتَلُ فِي سَبِيلِ اللَّهِ أَمْوَاتٌ بَلْ أحيَاءٌ وَلَكِنَّا نَشْعُرُونَ

Do not say of those who are killed in the cause of Allah, "They are dead"; they are alive but you do not feel it.

this is in addition to the more famous verse 3:169:

أَعُوذُ بِاللَّهِ مِنَ الشَّيْطَانِ الرَّجِيمِ بِسْمِ اللَّهِ الرَّحْمَنِ الرَّحِيمِ

وَلَا تَحْسِبَنَّ الَّذِينَ قُتِلُوا فِي سَبِيلِ اللَّهِ أَمْوَاتًا بَلْ أحيَاءٌ عِنْدَ رَبِّهِمْ يُرْزَقُونَ

Do not count those who are killed in the cause of Allah as dead; they are alive with their Lord, enjoying His provisions.

These two verses make it abundantly clear that those who die in the cause of Allah (e.g. martyrs) will not go into an intermediately Barzakh life (البرزخ) but return directly to Allah without judgment and are indeed alive watching our petty little chase after worldly desires and forgetting the real reason why we are here which is to worship our Creator.

This is exactly why at the end of each prayer when we directly greet our beloved and really **alive** Prophet (pbuh+f) we must wait for a reply from him for at least 1 second and feel it too, and Allah knows best.

This is also the exact reason why visiting the shrines of the Prophet or any member of his family (peace be upon them all) or their companions and followers or indeed visiting the graves of any martyr we may talk to them and although we may not hear their replies, they do hear us loud and clear, all of us and at the same time too.

Just as you are going to read the following greeting upon the Prophet (pbuh+f) you should pause for at least 1 second to allow for his personal real reply:

السَّلَامُ عَلَيْكَ أَيُّهَا النَّبِيُّ وَرَحْمَةُ اللَّهِ وَبَرَكَاتُهُ

Peace to you, oh Prophet of Allah and may His mercy and blessings be continuously upon you.

Please wait a second for the reply ...

All these basic beliefs are a must for any Muslim who believes in the Unseen (عالم الغيب) as per Allah instructions in Quran 2:1-5:

أعوذ بالله من الشيطان الرجيم بِسْمِ اللَّهِ الرَّحْمَنِ الرَّحِيمِ

In the name of Allah, the Merciful, the Benevolent. بِسْمِ اللَّهِ الرَّحْمَنِ الرَّحِيمِ

Alef Lam Meem.

1. الم

2. ذَلِكَ الْكِتَابُ لَا رَيْبَ فِيهِ هُدًى لِّلْمُتَّقِينَ

This book; there is no doubt in it; is a guide to those who guard (against evil).

3. الَّذِينَ يُؤْمِنُونَ بِالْغَيْبِ وَيُقِيمُونَ الصَّلَاةَ وَمِمَّا رَزَقْنَاهُمْ يُنفِقُونَ

Those who believe in the **Unseen** and keep up prayer and spend out of what We have bestowed upon them in charity and good deeds.

4. وَالَّذِينَ يُؤْمِنُونَ بِمَا أُنزِلَ إِلَيْكَ وَمَا أُنزِلَ مِنْ قَبْلِكَ وَبِآخِرَةِ هُمْ يُوقِنُونَ

And who believe in what has been revealed to you and what was revealed before you and they are certain of the hereafter.

5. أُولَئِكَ عَلَىٰ هُدًى مِّن رَّبِّهِمْ وَأُولَئِكَ هُمُ الْمُفْلِحُونَ

These are on a guided path by their Lord and these are the successful ones.

And to emphasize that returning to Allah is not death but going straight to Paradise without judgment, Allah Almighty says in Quran 3:55:

أعوذ بالله من الشيطان الرجيم بِسْمِ اللَّهِ الرَّحْمَنِ الرَّحِيمِ

إِذْ قَالَ اللَّهُ يَٰعِيسَىٰ إِنِّي مُتَوَفِّيكَ وَرَافِعُكَ إِلَيَّ وَمُطَهِّرُكَ مِنَ الَّذِينَ كَفَرُوا وَجَاعِلُ الَّذِينَ اتَّبَعُوكَ فَوْقَ الَّذِينَ كَفَرُوا إِلَىٰ يَوْمِ الْقِيَامَةِ ثُمَّ إِلَىٰ مَرْجِعِكُمْ فَأَحْكُمُ بَيْنَكُمْ فِيمَا كُنْتُمْ فِيهِ تَخْتَلِفُونَ

"When Allah said to Jesus, I am taking you back and raising you to Me and purifying you from those the disbelievers and promoting those who follow your teaching above those the disbelievers till Judgment Day when you all come to me so I clarify to you the matters in which you were disputing amongst yourselves."

Nearness to God

In Islam, **to bless** (صلاة على) means "to wish someone to be brought nearer to Allah" while **to curse** (لعنة على) means "to wish someone to be kept further away from Allah" this is why we call prayer **Salaat** (صلاة) which is the act of trying to be nearer to Allah and this is why we offer Salawat (صلاة على) to our Prophet and his family so may Allah bring them even nearer to Himself.

So what does **nearer to** or **further from** mean? I think, and Allah knows best, that because Allah says is Quran 24:35: *Allah is The Light of Heavens and Earth*, that coming nearer to Allah means getting rid of all impure frequencies and keep only main harmonics to be in tune with Allah's Pure frequency (a pure circle of π to the infinite decimal).

This is exactly what is meant by Quran 33:33:

أعوذ بالله من الشيطان الرجيم بِسْمِ اللَّهِ الرَّحْمَنِ الرَّحِيمِ

قَرْنَ فِي بُيُوتِكُنَّ وَلَا تَبَرَّجْنَ تَبَرُّجَ الْجَاهِلِيَّةِ الْأُولَىٰ وَأَقِمْنَ الصَّلَاةَ وَآتِينَ الزَّكَاةَ
وَأَطِعْنَ اللَّهَ وَرَسُولَهُ إِنَّمَا يُرِيدُ اللَّهُ لِيُذْهِبَ عَنْكُمُ الرِّجْسَ أَهْلَ الْبَيْتِ وَيُطَهِّرَكُمْ
تَطْهِيرًا

And stay in your houses and do not display your finery like the displaying of the ignorance of yore; and keep up prayer, and pay the poor-rate, and obey Allah and His Messenger. Allah only desires to keep away the uncleanness from you, O people of the House! and to purify you exponentially.

Conversely, making further away from Allah means add impurity and out of synch non-harmonic frequencies to a deserving selfish soul until it becomes a complete Square requiring infinite approximations to become near to Allah, the Pure Circle [http://en.wikipedia.org/wiki/Fourier_series] and that is the worst punishment ever.

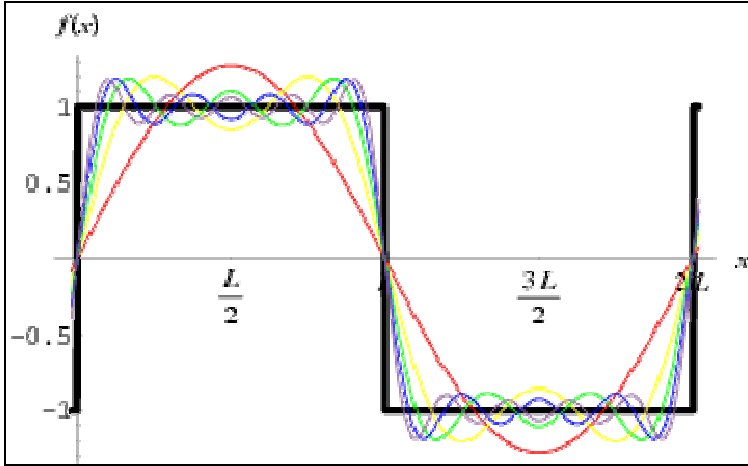

Fourier approximation of a Square into an infinite series of sine waves

Moreover, when Allah, *the Pure Light* says in Quran 89:22:

أَعُوذُ بِاللَّهِ مِنَ الشَّيْطَانِ الرَّجِيمِ بِسْمِ اللَّهِ الرَّحْمَنِ الرَّحِيمِ

وَجَاءَ رَبُّكَ وَالْمَلَكُ صَفًّا صَفًّا

And when your Lord comes, and the angels, row upon row.

This verse may mean Allah's pure frequency will propagate encompassing and enveloping all His angels which are almost pure but not quite as they still consists of harmonics or multiples of Allah's fundamental or single frequency.

Now, all praise due to Allah for purifying our beloved Prophet and his family more than even the purest of angels Gabriel, and that is why the Prophet (pbuh+f) was able to go through the higher energy layers of heavens further than Gabriel (as) and be closer to Allah, The Pure (قاب قوسين أو أدنى).

All praise is due to Allah, the God of all worlds, Seen and Unseen, may He forgive me for any errors inadvertently introduced with this concept, and correct me in due time in sha Allah.

Freewill versus Predestination

In politics, choice is nothing but an elusion. You get to vote for one of two faces of the same coin. Regardless of who wins, once in power they simply implement a pre-determined plan by their masters; the shadowy government. Voters are kept happy thinking they have a choice, but in reality it is just a game. **No free thinking is left, so long as they were fed.** All this is schemed by man to control man with the help of the Satan (may Allah curse and condemn him to Hell for eternity).

In Allah's law, that is Islam or submission to Allah Almighty alone, individual rights and responsibilities are clearly defined in Quran 91:7–10:

أعوذ بالله من الشيطان الرجيم بِسْمِ اللَّهِ الرَّحْمَنِ الرَّحِيمِ

<i>And a soul and Him Who perfected it</i>	7. وَنَفْسٍ وَمَا سَوَّاهَا
<i>And taught it what is wrong and what right for it.</i>	8. فَأَلَّهَمَّهَا فُجُورَهَا وَتَقْوَاهَا
<i>He is indeed successful who purifies it,</i>	9. قَدْ أَفْلَحَ مَنْ زَكَّاهَا
<i>And he will indeed fail who corrupts it.</i>	10. وَقَدْ خَابَ مَنْ دَسَّاهَا

Freewill is indeed entrusted to all souls of Man and Jinn but with continuous guidance from Allah, the All-knowing. At any given moment, Allah gives us two clear choices to climb the tree of life branching through its either good or evil sides. Choices on offer are totally dependent on all previous decisions we have made, although from time to time you may be deserving of a joker test that jumps you few branches aside.

We all start at the bottom of the tree climbing up its trunk as children with little responsibility and lots of joy and happiness unaware of the approaching stage where we would become accountable for our decisions.

Once we become adults, Allah would start us with simple tests to help us up the good side of the tree of life. The older we become the more difficult the tests become. If one passes his/her tests then Allah Almighty as part of His Mercy may consider him/her worthy of more severe tests, until he/she proves that they are worthy of being kept on the Right Path at which point Allah Almighty make is easier to stay as per Quran 92:5–7:

أعوذ بالله من الشيطان الرجيم بِسْمِ اللَّهِ الرَّحْمَنِ الرَّحِيمِ

<i>Who he gives to charity and maintains righteousness,</i>	5. فَأَمَّا مَنْ أَعْطَىٰ وَاتَّقَىٰ
<i>And upholds the scripture,</i>	6. وَصَدَّقَ بِالْحُسْنَىٰ
<i>We will lead him towards happiness (on the right path).</i>	7. فَسَنيسرُهُ لِيَسْرَىٰ

But if he/she starts climbing the evil side of the tree of life by constantly deciding on bad choices then Allah will keep trying to present him/her with good options until totally gives up on his/her when he/she reaches the point of no return at which time Allah Almighty will make it easier for him/her to stay in sin, as per Quran 92:8–10:

أَعُوذُ بِاللَّهِ مِنَ الشَّيْطَانِ الرَّجِيمِ بِسْمِ اللَّهِ الرَّحْمَنِ الرَّحِيمِ

But he who is stingy, to be even richer.

8. وَأَمَّا مَنْ بَخِلَ وَاسْتَغْنَىٰ

And belies the scripture.

9. وَكَذَّبَ بِالْحُسْنَىٰ

We will lead him towards misery (on the wrong path).

10. فَسَنُيَسِّرُهُ لِلْعُسْرَىٰ

However, as a Mercy from Him, Allah occasionally gives out a joker option to those who are deep in sin to take them all the way back to the middle of the tree for a fresh start but only if they show regret and remorse while hanging on the evil side of the tree.

You see if this was not true, then Satan would have an excuse to say to Allah Almighty you predetermined my destiny and as You claim to be fair then You should not punish me for I was never free!

Life is nothing but a climb up a tree of continuous choices with a controlled freewill. Allah will only guide us if we deserve it. If we don't, He would put clear obstacles in our way to correct us until we ignore them all, at which point we would have only ourselves to blame.

The other small problem of course is that anyone who is judged to serve in Hell would argue if Allah knew in advance that I will end up in Hell, then why did He create me? Well, the answer, and it is only a speculation, is that at the realm of Thar (the Spirit domain) prior to this life, we were free to ask to be born into this lower life (Dunya) or not as free-willed souls.

Although some were warned that they would end up in Hell, they still insisted on tasting this life regardless. They chose temporary enjoyment instead of permanent delayed one for lack of foresight, and Allah knows best.

As I already said, this is a speculation only and hope someone really clever can come up with a better reason why some are so dumb. ☺

May Allah keep us on the right path with His limitless Mercy, in sha Allah.

Year Types in Arabic

In Arabic there are two different words for “Year” (سنة sana) and (عام aam) as in Quran 29:14:

أَعُوذُ بِاللَّهِ مِنَ الشَّيْطَانِ الرَّجِيمِ بِسْمِ اللَّهِ الرَّحْمَنِ الرَّحِيمِ

وَلَقَدْ أَرْسَلْنَا نُوحًا إِلَىٰ قَوْمِهِ فَلَبِثَ فِيهِمْ أَلْفَ سَنَةٍ إِلَّا خَمْسِينَ عَامًا
فَأَخَذَهُمُ الطُّوفَانُ وَهُمْ ظَالِمُونَ

And We have sent Noah to his people and he stayed amongst them a thousand years (sana) except fifty years (aam). Then suddenly the deluge overtook them for they were unjust.

According to Dr. Abdul-Aziz Al-Harbi the two words represent exactly the same length of time but the word (سنة sana) is used for a year of hardship and/or struggle while the word (عام aam) is used for a year full of ease and luxury [<http://www.aljamaa.info/vb/showthread.php?p=90887>].

In fact, in the classical Arabic the word (سنة sana) is a synonym with the word famine and drought while the word (عام aam) is used for future years optimistically.

So in the above Quranic verse, Noah stayed amongst his people a 1000 years, 950 of which are spent in preaching his people who continuously ridicule him and only 50 easy years in which maybe divided into two parts, one part before he started his Prophethood at 40 most likely and the second part is the last 10 years before the great flood with the believers who later came with him on his ark, Noah's Ark.

It is therefore wrong to say he lived for 950 years as he lived a full **1000** years before he sailed ship and only Allah knows how long did he live after parting company with his people.

Therefore the above verse should be translated into English as follows:

Quran 29:14:

أعوذ بالله من الشيطان الرجيم بسم الله الرحمن الرحيم

وَأَقْدُرُ أَرْسَلْنَا نُوحًا إِلَىٰ قَوْمِهِ فَلَبِثَ فِيهِمْ أَلْفَ سَنَةٍ إِلَّا خَمْسِينَ عَامًا
فَأَخَذَهُمُ الطُّوفَانُ وَهُمْ ظَالِمُونَ

*And We have sent Noah to his people and he stayed amongst them a thousand years of **hardship** except for fifty **easy** ones.
Then suddenly the deluge overtook them for they were unjust.*

And here are few examples from the story of Joseph in the Quran that should make the evidence even clearer:

Quran 12:42:

أعوذ بالله من الشيطان الرجيم بسم الله الرحمن الرحيم

وَقَالَ لِلَّذِي ظَنَّ أَنَّهُ نَاجٍ مِّنْهُمَا اذْكُرْنِي عِنْدَ رَبِّكَ فَأَنسَىٰهُ الشَّيْطَانُ ذِكْرَ رَبِّهِ فَلَبِثَ فِي السِّجْنِ بِضْعَ سِنِينَ

*And he said to him whom he knew would be delivered of the two: Remember me with your lord; but the Satan caused him to forget mentioning (it) to his lord, so he remained in the prison a few years (sena) of **hardship**.*

Quran 12:47:

أعوذ بالله من الشيطان الرجيم بسم الله الرحمن الرحيم

قَالَ تَزْرَعُونَ سَبْعَ سِنِينَ دَأْبًا فَمَا حَصَدْتُمْ فَذَرُوهُ فِي سُنْبُلِهِ إِلَّا قَلِيلًا مِّمَّا تَأْكُلُونَ
*He said: You shall sow for seven years (sena) of **hardship** continuously, then what you reap leave it in its ear except a little of which you eat.*

Quran 12:49:

أعوذ بالله من الشيطان الرجيم بسم الله الرحمن الرحيم

ثُمَّ يَأْتِي مِنْ بَعْدِ ذَلِكَ عَامٌ فِيهِ يُغَاثُ النَّاسُ وَفِيهِ يَعَصِرُونَ

*Then there will come after that an **easy** year (aam) in which people shall have rain and in which they shall press (grapes).*

Hijri Date Line

A day on a spinning Earth needs to start along some horizon as Sun light sweeps the globe. In the late 1800s, England was advanced astronomically proposed dividing the globe into 24 time-zones with the reference time-zone being the Greenwich Mean Time along longitude 0° or *The Prime Meridian*.

The Earth was therefore divided into 360 longitude degrees, 180° to the east of the Meridian called the *Eastern Hemisphere* and 180° to the west of the Meridian called the *Western Hemisphere*. Where the two hemispheres meet (on the opposite side of the Earth in the middle of the Pacific Ocean along longitude 180°), an *International Date Line* was defined to bridge the day-long gap between neighboring lands on either side. The date to the east of line is always one day earlier than it is to the west. If the time to the **east** of the line is 2012-12-21 11:11 then the time to the **west** side is 2012-12-22 11:11.

Although the IDL serves as the official world calendar divider, new days at each location on Earth officially start at their respective local midnight times (**00:00**) and sweep smoothly except when reaching the IDL where the date suddenly jumps from by one day forward if moving west to east and entering the Eastern Hemisphere or one day backward if moving east to west and entering the Western Hemisphere and one day.

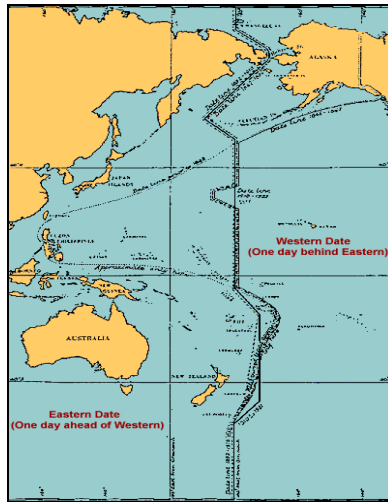

Eastern and Western Hemispheres of the Earth
[http://aa.usno.navy.mil/faq/docs/international_date.php]

The International Date Line is a civil tool and is independent of the natural Earth horizon at sunrise or at sunset. For convenience, the IDL occasionally diverges from its 180° longitude line to pass around some island groups so as not to divide them into two separate dates as shown below:

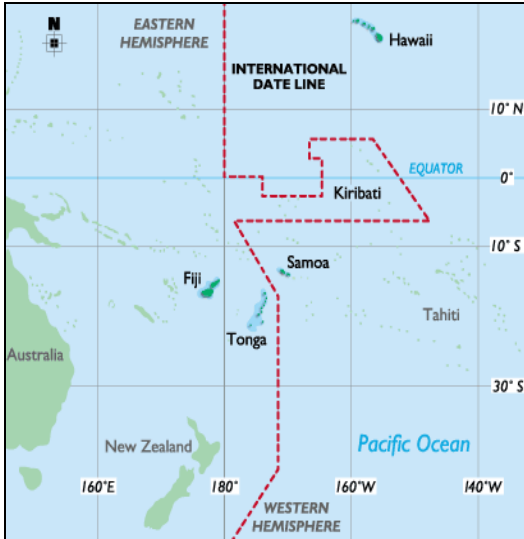

The International Date Line

[<http://www.worldatlas.com/aatlas/infopage/dateline.htm>]

In Islam, a new Day starts at the local sunset (not at 00:00) of that location which varies daily around a solar year cycle. To complicate matters, months in Islam are lunar and unlike days which are linked to the Sun, months are linked to the Moon. Furthermore, no Dateline is defined and different locations on Earth use different dates and sometimes months at the same time.

There is a real need for a Hijri Date Line to be defined to help unify the Hijri Calendar and it is therefore proposed that the natural daily sunset horizon over Makkah be considered as the Hijri Date Line or more precisely the **Hijri Date Arc** along the forefront of the Sunset Arc horizon peeling off the daylight and covering it with night.

As soon as it is sunset over Makkah every land to the west starts their new day at their respective sunset sweep over until almost 24 hours later it reaches the land to the east of Makkah and a new day is born. Once the same horizon reached Makkah again then a new cycle begins.

This would explain why we have two sets of sayings (Hadith) of the Prophet (pbuh+f) where one set claiming that Imam Mehdi (may Allah bring forward his reappearance) will appear on a Friday while another set claiming Saturday.

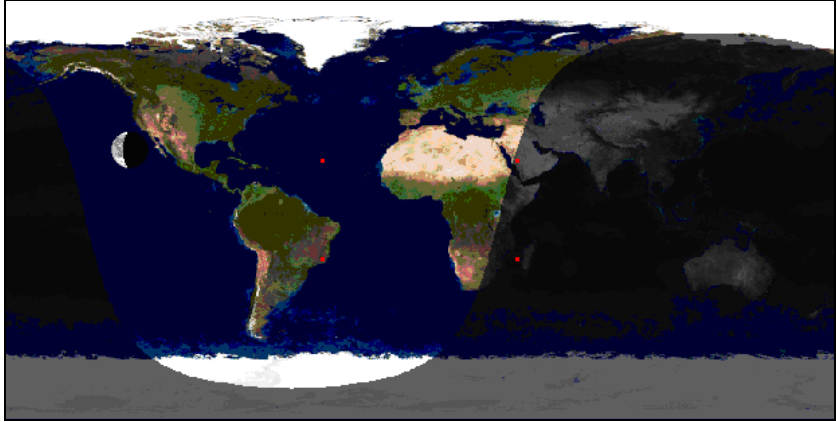

Hijri Date Arc with Sunset over Makkah with Four Golden Points***

If such a Hijri Date Arc is considered, then the Imam can declare his presence at sunset in the Holy Kabba in Makkah. All land to his east will be Friday while land to his west is slowly becoming Saturday as sunset sweeps over it.

As Allah first chose Jerusalem to be the prayer direction point only to change it later to Makkah, this may suggest that the first ever horizon the Earth started its night-day cycle with passed through both cities simultaneously.

***Golden Points split the common map of the world into golden ratio lengths with one point near Makkah. But what are the other three points for? And contrary to what was spread on the Internet, Quran 3:96: "إِنَّ أَوَّلَ بَيْتٍ وُضِعَ لِلنَّاسِ لَلَّذِي بِبَكَّةَ مُبَارَكًا وَهُدًى لِلْعَالَمِينَ" has 41 words and biBakkah starts at letter 22.

Continuous horizon drift due Earth's precession (a very slow wobbling on its axis that shifts the equinoxes and solstices positions 1° every 71.5 years) means that this occurrence *may* reoccur every precession cycle which

current science says it takes 26,000 years while Allah All-knowing states that the angels and the Spirit need 50,000 years to ascent to Him as per Quran 70:4:

أَعُوذُ بِاللَّهِ مِنَ الشَّيْطَانِ الرَّجِيمِ بِسْمِ اللَّهِ الرَّحْمَنِ الرَّحِيمِ

تَعْرُجُ الْمَلَائِكَةُ وَالرُّوحُ إِلَيْهِ فِي يَوْمٍ كَانَ مِقْدَارُهُ خَمْسِينَ أَلْفَ سَنَةٍ

To Him ascend the angels and the Spirit in a day the measure of which is fifty thousand years.

Interestingly, the #1 astronomy software vendor in the world, Space.com used to have the Sun year (time orbiting our galaxy) in exactly 50000.0000 years! When I reported the above Quranic verse to them they claimed it was a bug in their software and they since removed it. Here is the old picture from their StarryNight Backyard 3.12:

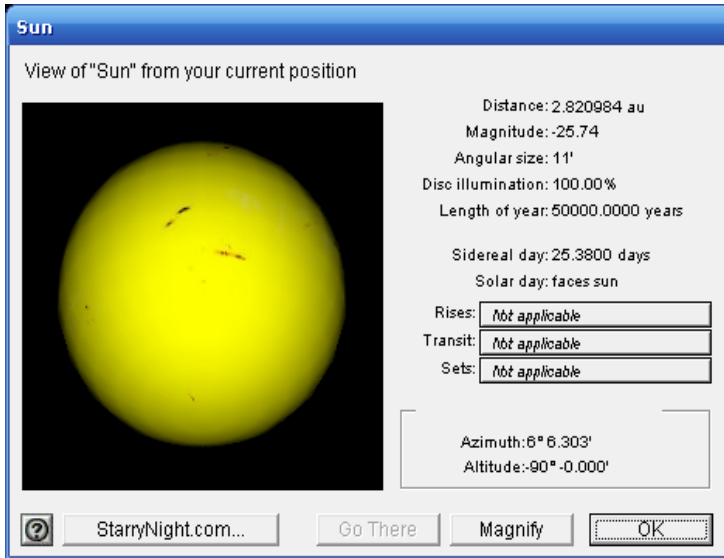

StarryNight Backyard 3.12 – Sun Info Window

This is why the upcoming galactic alignment of the Earth and Sun with the centre of our Galaxy on 21st December 2012 is such an important event as it may bring a truly new day for a truly new beginning, and Allah knows best.

Nuclear Fusion in the Quran

In a BBC documentary [<http://news.bbc.co.uk/2/hi/science/nature/4270297.stm>] about nuclear fusion and sonoluminescence [<http://en.wikipedia.org/wiki/Sonoluminescence>] a new nuclear reaction was induced by bombarding a gas bubble inside a **special liquid** inside a glass container with very high intensity sound waves until the bubble collapses resulting in a brilliant flash of light due to extreme pressures and temperatures in the range 10-100 million °C.

Energy companies were quick to kill off the idea of Prof. Rusi Taleyarkhan* [http://en.wikipedia.org/wiki/Rusi_Taleyarkhan] by forcing the programme makers to conclude that although flashes of lights were produced and excess neutrons were detected, the reaction is not a nuclear reaction because the detection was not at the same nanosecond as the flashes totally overlooking the resultant energy. They did not even try to look for a *constant time gap* between the flashes and the detections to prove any correlation between the two events.

This immediately reminded me of Quran 24:35 which may be a recipe for a very similar method of producing clean and cheap energy at home:

أعوذ بالله من الشيطان الرجيم بِسْمِ اللَّهِ الرَّحْمَنِ الرَّحِيمِ

اللَّهُ نُورُ السَّمَوَاتِ وَالْأَرْضِ ۗ مِثْلُ نُورِهِ كَمِشْكَاةٍ فِيهَا مِصْبَاحٌ الْمِصْبَاحُ فِي زُجَاجَةٍ ۗ
الزُّجَاجَةُ كَأَنَّهَا كَوْكَبٌ دُرِّيٌّ يُوقَدُ مِنْ شَجَرَةٍ مُبْرَكَةٍ زَيْتُونَةٍ لَا شَرْقِيَّةٍ وَلَا غَرْبِيَّةٍ يَكَادُ
زَيْتُهَا يُضِيءُ وَلَوْ لَمْ تَمْسَسْهُ نَارٌ ۗ نُورٌ عَلَى نُورٍ ۗ يَهْدِي اللَّهُ لِنُورِهِ ۗ مَنْ يَشَاءُ ۗ
وَيَضْرِبُ اللَّهُ الْأَمْثَلَ لِلنَّاسِ ۗ وَاللَّهُ بِكُلِّ شَيْءٍ عَلِيمٌ

Allah is the Light of the heavens and the earth. The Parable of His Light is as if there were a Niche and within it a Lamp: the Lamp enclosed in Glass: the glass as it were a pearl-like planet: Lit from a blessed Tree, an Olive, neither eastern nor western, whose oil is almost luminous, though no fire touches it: Light upon Light! Allah guides whom He will to His Light: Allah sets forth Parables for men: and Allah knows all things.

I have contacted Prof. Taleyarkhan and he personally confirmed that four more successful experiments showed that nuclear reaction (not cold but hot fusion) was indeed taking place. Soon after, he was forced to abandon his research at Oak Ridge National Laboratory due to alleged research misconduct without evidence and was instead restricted to teaching duties at Purdue University.

* Rusi P. Taleyarkhan, Ph.D., MBA, Professor, 400 Central Drive, College of Engineering, Purdue University, W. Lafayette, IN 47907-1290, Tel: (765)-420-7537, Email: rusi@purdue.edu

Humanity ought to study this verse very closely in light of the above sonoluminescence experiments and perhaps use **olive oil** as that **special liquid** as per the Quranic recipe, that is neither eastern nor western which may mean **isotopes** of the compounds of whatever olive oil is made of, and Allah guides those who seek Him.

I have tried to find out more about olive trees and have come across this interesting research done by a Prof. Abdelmajid Belabed* showing light-emitting olive seeds

[<http://www.miracweb.net/index.php/2009-05-30-02-29-25/137-2009-07-14-22-33-45>]:

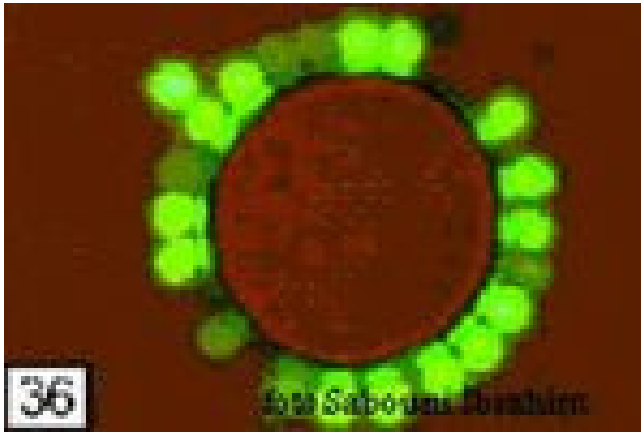

Light-emitting Olive Seeds

Another investigation of sonoluminescence using olive oil mixed with other solutions [<http://oas.ucok.edu/96/T96/Mkline.htm>] confirmed its effectiveness at prolonging the bubble lifetime.

While a newly formed company, AquaPhotonics [<http://www.aquaphotonics.com>] has commercialized Prof. Taleyarkhan's research and used olive oil for potential nanotechnology skincare, cosmetic, ophthalmic pharmaceutical, and eye-care products using their Aquaphotonics technology. Here is what they say on their website at [<http://www.aquaphotonics.com/technology.html>]:

* Abdelmajid BELABED, Ph.D., Professor, Université Mohamed Premier, Faculté des Sciences, Département de Biologie, B.P 724 Oujda 60000, MAROC., Email: belabed_abdelmajid@yahoo.fr

Researchers at the Oak Ridge National Laboratory (ORNL), Rensselaer Polytechnic Institute and the Russian Academy of Sciences have reported results that suggest the possibility of nuclear reactions during the explosive collapse of bubbles in liquid, a process known as cavitation. The bubbles, which grow in the presence of sound waves, collapse to produce locally high pressure and temperatures. When a sound wave propagates through a liquid, the molecules in the liquid are subjected to positive and negative pressures. During the negative phase of the wave, tiny bubbles in the liquid can grow dramatically (up to a factor of 1000 in volume), since the pressure is below the vapor pressure. When the positive pressure phase of the sound wave passes, the bubble collapses, and the energy accumulated in the bubble during growth is released. This process is known as "acoustic cavitation".

Temperatures in the collapsing bubbles can reach 10,000,000 Kelvin, sufficient to influence chemical reactions. These pressures and temperatures can be sufficiently high to result in light emissions, called sonoluminescence, from the collapsing bubbles. This suggests the possibility of producing densities and temperatures necessary for nuclear reactions. In particular, a long-sought goal of sonoluminescence research has been the possibility of achieving nuclear fusion reaction conditions.

NASA, the National Aeronautics and Space Administration meanwhile summarized its findings regarding **Sonoluminescence** as a **star in a jar** [http://ntrs.nasa.gov/archive/nasa/casi.ntrs.nasa.gov/20050217027_2005218573.pdf]:

Sonoluminescence: A Galaxy of Nanostars Created in a Beaker

As part of basic and applied research on advanced instrumentation technologies, the NASA Glenn Research Center is examining applications for sonoluminescence: ultrasonically produced glowing bubbles that are hotter than the Sun. In the last decade, those outside of the ultrasonic community have become interested in understanding sonoluminescence and in using some of its more interesting properties. First discovered in the 1930s as a byproduct of early work on sonar, the phenomenon is defined as the generation of light energy from sound waves. This glow, which was originally thought to be a form of static electricity, was found to be generated in flashes of much less than a billionth of a second that result when microscopic bubbles of air collapse. The temperature generated in the collapsing bubbles is at least 4 times that of the surface of the Sun.

Theories for the cause of the glow from a collapsing bubble range from black-body radiation, plasma ionization, quantum vacuum fluctuations, or coherent optical lasing. Even as these theories are being explored, applications for the effect are taking shape, from fusion containment to thin-film deposition systems. Glenn has begun an in-house examination of sonoluminescence to develop instrumentation and measurement techniques that could ultimately use the phenomenon to enable safer, lighter, quieter, and more fuel efficient vehicles for aeronautics and space transportation and exploration.

Helical Particle Waves

The concept of electromagnetic waves having frequency, wavelength and amplitude is easily understood today. However physicists are still today unable to explain how a stream of photons can behave as both a stream of particles and as a wave at the same time and satisfy themselves by claiming it is mass when you look for mass and it is wave when you look for wave properties but never at the same time. They are even unable to determine both the velocity and the position of a relativistic particle at the same time.

In his theory, *Helical Particle Waves*, [www.heliwave.com], Mr. J. L. Gaasenbeek proposes that all particles such as electrons, protons, and neutrons are in fact made up of billions upon billions of photons orbiting in pairs within these particles and continuously being emitted as electric fields around their particles that are spinning around themselves, helicating around their line of motion, and moving forward along their line of motion as shown here:

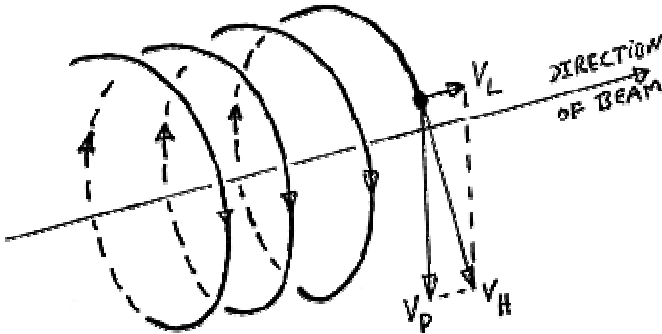

A Helical Particle Wave

Helical Particle Waves theory naturally explains most, if not all of the observed phenomena naturally without having to resort to artificial arguments such as space-time distortion produces gravity, or magically the mass of a particle changes as a function of its velocity. It even explains that magnetism rises from the continuous spin of electrically charged particles.

All this confusion stems from the misunderstanding of the motion of particles at relativistic velocities. Spin and helication was never taken into account when calculating the momentum or the kinetic energy of a relativistic particle and thus excess energy had to go somewhere and what is more tempting to do than increase the mass of an object to infinity as its velocity approaches the speed of light c . Total falsification of reality.

Such artificially concepts (e.g. time/mass/length dilation, space-time curvature) in essence turned science into a cult, which could only be understood by the selected few (the initiated).

Gaasenbeek said: “*They reached the top of the wrong tree and refuse to climb down in search of the true tree of knowledge*”.

Dual Nature of Light

The dual nature of light (being matter and wave at the same time) can be readily explained as a continuous stream of spinning and revolving photons forming a spring-like wave of photons, the most fundamental matter in our universe or the energy quantum of Planck's constant (6.626×10^{-34} J·s). Therefore both behaviors wave-like and matter-like are concurrently present and do not exclude each other as assumed by current physics.

Photons consume external energy to power their three motions:

- **spin motion** around their own axis,
- **linear motion** forward limited to the speed of light c , and
- **helical motion** with fixed amplitude and frequency.

Accelerating a helical photon towards the speed of light increases its spin and helical moment (turning effect) not its linear momentum (velocity) because photons cannot overtake each other. Immediately after leaving its source, a photon has to fall in step with other photons in the ocean of photons outside its source and therefore its linear velocity cannot exceed the constant speed of the light set to c (299792458 m/s) in our universe or domain. Other universes or domains may each have its own unique constant and frequency range (above ours) to avoid interacting with each other.

A particle's mass does not increase to infinity with its velocity approaching the speed of light c as suggested by Relativity but instead any excess in its momentum ($\mathbf{p} = \mathbf{m} \times \mathbf{v}$) is absorbed by the increase in its spin and angular (helical) moments.

Both spin and helical motions enable particles to absorb more energy than is simply required to accelerate them linearly. In fact, together they function as an intrinsic capacitor to store the excess acceleration energy that cannot be transformed into further linear motion as their velocity approaches c .

Gravitons and Inertial Mass

The more energy a relativistic particle absorbs, the higher its spin moment becomes and thus gains higher resistance to directional change. That is, a stream of relativistic particles (a helical particle wave) starts to lose amplitude as the velocity at which it propagates through space approaches c . **Gravitons** can be thought of as photons at the highest energy possible in this universe with almost zero amplitude and thus penetrate all matter particles. Particles are giant structures of photons that continuously emit some of their photons to keep their internal orbital engine “alive” by reactive forces.

Mass is a measurement of a particle's impedance to the passage of gravity field (graviton) through its matter and is thus directly proportional to both the number of photons it is made of and the way they interlock. This is exactly what current science is missing, hence the search for *God's Particle* or the *Higgs boson* [http://en.wikipedia.org/wiki/Higgs_boson].in the *Large Hadron Collider* [http://en.wikipedia.org/wiki/Large_Hadron_Collider] where scientists hope by colliding protons head on at speeds of 99.999% of c and studying the tracks of resultant fragments can reveal their new particles of higher energy that know currently.

Hadrons are large particles like protons or neutrons while **Leptons** are tiny particles like electrons or neutrinos. So it makes sense to use hadrons rather leptons to disintegrate and protons are used rather than neutron so their paths can be controlled by magnetic fields interacting with the positive moving electric charge (which are in essence tiny magnets).

Therefore it is suggested that the ocean of gravitons a particle swims in is the *real gravity field*, not the space-time curvature propose by Einstein which illogically assume time is part of reality. It must be stressed that gravity is real while time is a mere concept of before and after. No need for ideas such as time dilation as this can be easily explained by different observers observing the same event at different points in the global absolute time based on their position in the global XYZ in our Universe with respect to the event.

“The more I know, the more I realize how much more there is to know!”

J. L. Gausenbeck, 1990

Electric Charges and Magnetic Moments

It is quite possible that electrons and protons start live with exactly the same number of photons giving them the same electric charge but opposite polarity ($Q_{e^-} \approx -1.6 \times 10^{-19} \text{ C}$, $Q_{p^+} \approx 1.6 \times 10^{-19} \text{ C}$) due to different internal structure arrangements. These arrangements impede gravity field differently resulting in different masses ($M_{e^-} \approx 9.1 \times 10^{-31} \text{ kg}$, $M_{p^+} \approx 1.67 \times 10^{-27} \text{ kg}$) [<http://en.wikipedia.org/wiki/Proton> and <http://en.wikipedia.org/wiki/Electron>].

Spinning and forward moving electrical charges distort their photon radiation paths resulting in magnetic moment (or turning effect inside the ocean of external photons). This is what magnetism is all about just as an electric conductor gives out a cylindrical magnetic field around itself when an electric current (electrons) passes through it.

On a macro level however, the half-life of a nucleus can be viewed as the stability of internal structure arrangements of protons and neutrons. The easier to disturb these arrangements, the less stable a nucleus is and its neutrons can change into protons and electrons destabilizing the whole nucleus macro structure and disintegrating it in the process into other elements or isotopes.

Positive-Negative Neutrons

Neutrons can be viewed as particles with alternating electric charge. They rapidly alternate their charge direction as their structure continuously alters its way of interlocking. When a neutron's charge becomes positive, it repel its surrounding protons but soon it reverts back to negative pulling back the same protons. This love-hate relationship is what keeps the particles spinning (i.e. alive) and contained within the nucleus.

When gravitons bombard a particle living in this gravity ocean (or Ether as used to be called by the ancients), they either pass through without any interaction, or hit one of its photons and causes its orbital relationship with its pair to collapse, resulting in the emission of both photons along different helical paths (possibly in opposite directions).

Double Helix Electromagnetic Fields

The number of correlated helical paths and their directions (i.e. clockwise or counter clockwise) determines the characteristics of a helical photon wave. Electromagnetic fields may well be double helix photon waves, where each electric and magnetic field is a single helix wave helicating in opposite direction to the other, in a similar fashion to our genetic Deoxyribonucleic Acid (DNA) double helix [<http://en.wikipedia.org/wiki/DNA>].

Nature's Binding Forces

Helical particle waves can be used to redefines nature's binding forces as follows from weakest to strongest:

1. The *Gravitational Force* that binds masses in the same universe. As gravitons emitted from a particle, they cause a reactive force in the opposite direction to their emission and away from their source. A mass in isolation would emit gravitons equally in all directions and therefore does not experience a resultant force. However, two masses will influence each other's gravitational field causing each mass to emit more gravitons away than towards each other and hence resulting is a continuous but pulsating force between them and thus gravitational acceleration at the macro level.
2. The *Electromagnetic Force* that binds electrically charged spinning particles due to the interaction between emitted photons of both particles (i.e. electrical, magnetic or electromagnetic fields).
3. The *Strong Nuclear Force* that binds electrically charged particles of the same polarity (e.g. +ve/+ve or -ve/-ve) by continuously alternating the polarity (helication direction) of the emitted photons of the medium between them and thus continually attract and repel the particles. Neutrons inside the nucleus acts as such mediators because of their alternating positive-negative charge which glues the protons inside the nucleus and keep them from flying off. Conversely, the *Weak Nuclear Force* which is currently defined as the force responsible for radioactivity, or the half-life of an isotope, does not in fact exist. Instead, radioactivity can be the result of the natural photons exchange between protons and neutrons inside a nucleus as suggested above. During this process, some neutrons change their internal structure and thus become protons and electrons which result in destabilization of the nucleus and possibly the disintegration into smaller elements.
4. The *Gaasenbeek Force*¹ is a newly proposed force that binds photons in an interlocked orbital structure resulting in a particle of a certain type. Highly energetic photons (gravitons) travelling through a particle may overcome this binding force by unlocking one of its inner orbits, which in turn may unlock its immediate surrounding orbits, and so on. This unlocking process if not controlled by the Gaasenbeek force could lead to the disintegration of the whole particle into photons only (or pure energy).

¹ In honour of J. L. Gaasenbeek, the founder of the Helical Particle Waves theory.

Supplication of Imam Mehdi

Allah Almighty teaches us how to be humble at all times even if we were to be bestowed with the gift as Prophethood by sharing with us the story of Prophet Yunus (pbuh) in Quran 37:139–148:

أعوذ بالله من الشيطان الرجيم بِسْمِ اللَّهِ الرَّحْمَنِ الرَّحِيمِ

139	وَأَن يُونُسَ لَمِنَ الْمُرْسَلِينَ <i>And Yunus was most surely of the messengers.</i>
140	إِذْ أَبَقَ إِلَى الْفُلِّكَ الْمَشْحُونِ <i>When he ran away to a ship completely laden,</i>
141	فَسَاهَمَ فَكَانَ مِنَ الْمُدْحَضِينَ <i>So he shared (with them), but was of those who are cast off:</i>
142	فَالْتَقَمَهُ الْحَوْتُ وَهُوَ مُلِيمٌ <i>So the fish swallowed him while he did that for which he blamed himself:</i>
143	قُلُوبًا أَنَّهُ كَانَ مِنَ الْمُسَبِّحِينَ <i>But had it not been that he was of those who glorify (Us),</i>
144	لَلْبَيْتِ فِي بَطْنِهِ إِلَى يَوْمِ يُبْعَثُونَ <i>He would certainly have tarried in its belly to the day when they are raised.</i>
145	فَنَبَذْنَاهُ بِالْعَرَاءِ وَهُوَ سَقِيمٌ <i>Then We cast him on to the vacant surface of the earth while he was sick.</i>
146	وَأَنْبَتْنَا عَلَيْهِ شَجْرَةً مِّنْ يَقْطِينٍ <i>And We caused to grow up for him a gourd plant.</i>
147	وَأَرْسَلْنَاهُ إِلَى مِئَةِ أَلْفٍ أَوْ يَزِيدُونَ <i>And We sent him to a hundred thousand, rather they exceeded.</i>
148	فَأَمَّنُوا فَمَرَّعْنَاهُمْ إِلَى حِينٍ <i>And they believed, so We gave them provision till a time.</i>

in which he continuously pleas with God for release as per Quran 21:87:

أعوذ بالله من الشيطان الرجيم بِسْمِ اللَّهِ الرَّحْمَنِ الرَّحِيمِ

وَدَا أَلْوَنٍ إِذْ دَهَبَ مُغْضِبًا فَظَنَّ أَنْ لَنْ نَقْدِرَ عَلَيْهِ فَنَادَى فِي الظُّلُمَاتِ أَنْ لَا إِلَهَ إِلَّا أَنْتَ سُبْحَانَكَ إِنِّي كُنْتُ مِنَ الظَّالِمِينَ <i>And Tha-alnoon, as he went away in anger and thought that We would not restrain him (due to his Prophethood status), he called out amid darkness: There is no god but You, glory be to You; I have been one of the wrongdoers.</i>

Similarly, our saviour Imam Mehdi could also be pleading to Allah for permission to bring forward his re appearance in order to restore peace and justice on Earth and establish the Rule of Allah for all beings (mankind and jinnkind) as per Quran 27:62:

أعوذ بالله من الشيطان الرجيم بسم الله الرحمن الرحيم

أَمَّنْ يُجِيبُ الْمُضْطَرَّ إِذَا دَعَاهُ وَيَكْشِفُ السُّوءَ
وَيَجْعَلُكُمْ خُلَفَاءَ الْأَرْضِ ۗ
أَعْلَاهُ مَعَ اللَّهِ قَلِيلًا مَّا تَذَكَّرُونَ

*Who answers the desperate and relieves the distress praying for removal of hardship and injustice and makes you the inheritors of Earth?
Is there a god beside Allah? Oh, how little you do remember.*

where “**makes you the inheritors of Earth**” is explained in Quran 21:105:

أعوذ بالله من الشيطان الرجيم بسم الله الرحمن الرحيم

وَلَقَدْ كَتَبْنَا فِي الزَّبُورِ مِنْ بَعْدِ الذِّكْرِ أَنَّ الْأَرْضَ يَرِثُهَا عِبَادِيَ الصَّالِحُونَ

And We wrote in the Psalms, after we decreed the law for all beings that only my righteous servants shall inherit Earth.

and “**Oh, how little you do remember**” is explained in Quran 7:172:

أعوذ بالله من الشيطان الرجيم بسم الله الرحمن الرحيم

وَإِذْ أَخَذَ رَبُّكَ مِنْ بَنِي آدَمَ مِنْ ظُهُورِهِمْ ذُرِّيَّتَهُمْ وَأَشْهَدَهُمْ عَلَىٰ أَنفُسِهِمْ
أَلَسْتُ بِرَبِّكُمْ
قَالُوا بَلَىٰ سَهِدْنَا
أَنْ تَقُولُوا يَوْمَ الْقِيَامَةِ إِنَّا كُنَّا عَنْ هَذَا غَافِلِينَ

And when your Lord brought forth from the children of Adam, from their loins, their seed, and made them testify of themselves, saying:

Am I not your Lord?

They answered: Yes, verily. We testify.

Never say on the Day of Judgment: Oh! Of this we were unaware!

If all Muslims recite this Quranic verse in full as a supplication not for personal gain but for bringing forward the appearance of our saviour whenever possible then when enough expectant people recite it at the same time at different parts of the earth then Allah may bless humanity with his appearance because we've earned it, and Allah knows best.

I therefore recommend reciting the above Quranic verse (27:62) exactly **313** times, the same number as his generals, after **Friday** prayer at least once in a lifetime. ☺

Primes Game

Here is a new game called **Primes** that is similar to *Snakes and Ladders*. I designed it to help schools teach their pupils prime numbers in a fun way.

	99 3×3×11	98 2×7×7	97 97	96 2×2×2×2×2×3	95 5×19	94 2×47	93 3×31	92 2×2×23	91 7×13
81 3×3×3×3	82 2×41	83 83	84 2×2×3×7	85 5×17	86 2×43	87 3×29	88 2×2×2×11	89 89	90 2×3×3×5
80 2×2×2×2×5	79 79	78 2×3×13	77 7×11	76 2×2×19	75 3×5×5	74 2×37	73 73	72 2×2×2×3×3	71 71
61 61	62 2×31	63 3×3×7	64 2×2×2×2×2×2	65 5×13	66 2×3×11	67 67	68 2×2×17	69 3×23	70 2×5×7
60 2×2×3×5	59 59	58 2×29	57 3×19	56 2×2×2×7	55 5×11	54 2×3×3×3	53 53	52 2×2×13	51 3×17
41 41	42 2×3×7	43 43	44 2×2×11	45 3×3×5	46 2×23	47 47	48 2×2×2×2×3	49 7×7	50 2×5×5
40 2×2×2×5	39 3×13	38 2×19	37 37	36 2×2×3×3	35 5×7	34 2×17	33 3×11	32 2×2×2×2×2	31 31
21 3×7	22 2×11	23 23	24 2×2×2×3	25 5×5	26 2×13	27 3×3×3	28 2×2×7	29 29	30 2×3×5
20 2×2×5	19 19	18 2×3×3	17 17	16 2×2×2×2	15 3×5	14 2×7	13 13	12 2×2×3	11 11
Primes ©2009	2 2	3 3	4 2×2	5 5	6 2×3	7 7	8 2×2×2	9 3×3	10 2×5

Primes Game Board

Game Parts

- A 10x10 square board with 100 squares numbered 1 to 100.
 - Odd number squares are colored black text on white background [white].
Even number squares are colored white text on black background [black].
Prime numbers are colored vividly red text on white background [red] except square 2 which is colored red text on black background [2] because 2 is an even prime number.
 - Square 1 is colored blue text on white [1] because 1 is not a prime number but is the Unit for all numbers.
- Two cubed dice with faces numbered 1, 2, 3, 4, 5 and 6.
- Four colored markers [red] [blue] [green] [yellow].

Game Goal

The goal of the game is to reach 100 without exceeding it.

Game Rules

Dice values can be added or subtracted to move forward if the player is currently on an odd number square (1, 3, 5, 7, 9, ...), or backward if the player is currently on an even number square (2, 4, 6, 8, 10, ...).

If the player is currently on a prime number square (2, 3, 5, 7, 11, ...) then dice values can be added, subtracted or multiplied to move forward.

Note that although 2 is an even number, it is also a prime number and a player moves forward if he or she is currently on it. 2 is the only even prime number.

Any player reaches 100 without exceeding it wins.

How to Play

2-4 players can play at a time. Each player rolls the dice and the sum of each player's dice value determines the starting order from highest to lowest.

All players start outside the board. Each player rolls the dice and choose to add or subtract the two dice values and put his or her colored marker on the square corresponding to the addition or the subtraction result (even if already occupied by another player) and wait his or her turn.

Once a player gets his or her turn, he or she rolls the dice again and based on his or her current square number (even, odd, or prime) choose to add, subtract or multiply and move forward or backward a number of steps equals to the result of addition, subtraction or multiplication.

If a player goes backward beyond 1 to outside the board then must restart.

Free Game Demo

Here is a software program of the game written in C# .NET 2.0 demoing the game with full user interaction. It is available for free from my website at www.heliwave.com or via email at heliwave@yahoo.com.

I used this program to test the playability of the game and on average a 4-player game would take ~10 minutes to reach near the 100 square but ~2-3 more minutes to land exactly on the 100 square and win the game.

The average number of moves for a 1000 runs of the game was ~23 moves.



Game Demo with my cute 19-day old thinker ©

24hr Clock

All praise to Allah, I have designed a new 24hr clock with a 24 hour face that displays day and night calculated dynamically based on the user location (latitude, longitude, and elevation) and the current day of the year.

It also displays the five Muslim prayer times (Shia and Sunni) for the selected location using five colorful hands.

All calculations are based on NASA Astronomical algorithms. A fully customizable Java-based program *24hr AstroClock* is shown below that is available for free with 100% source code from my website at www.heliwave.com or via email at heliwave@yahoo.com.



24-Hour Astronomical Clock
with shaded Day and Night
for current location on earth and day of year
and Five Prayer Times

Live clock at
www.heliwave.com/AstroClock.html

References

1. Allah

The Holy Quran:

610-632 [23 years of revelations by Allah through Angel Gabriel to the Prophet]

Recitation Method: **Hafs** bin Suleiman Al-Ghadhiri Al-Kufi ◀ Aasim bin abi Al-Nijood ◀ Abi Abdul-Rahmaan As-Selami ◀ Imam Ali bin abi Talib ◀ The Prophet Muhammed bin abd Allah (pbuh&f).

قراءة حفص بن سليمان الغاضري الكوفي ▶ عاصم بن أبي النجود ▶ أبي عبد الرحمن السلمي
▶ الإمام علي بن أبي طالب (ع) ▶ النبي محمد بن عبد الله (ص).

Writing Method: **Uthmani**. (الرسم العثماني)

2. Nadeem Al-Jisr

Story of Faith:

Philosophy, Science and Quran

Dar Al-Tarbeeya, 2003.

3. John Derbyshire

Prime Obsession:

Bernhard Riemann and the Greatest Unsolved Problem in Mathematics

Joseph Henry Press, 2003.

4. Marcus du Sautoy

Music of the Primes:

Searching to Solve the Greatest Mystery in Mathematics

HarperCollins, 2003

5. Carl Sagan

CONTACT

Simon & Schuster, 1985

6. The Internet

URL addresses are embedded were used.

About the Author

All praise and thanks are due to God, Allah, who guided me every step of the way. I am an Iraqi / British engineer with a BSc in Electrical Engineering (1st) from the University of Technology, Iraq (1988) and an MSc in Software Engineering from Bournemouth University, UK (1994).

After achieving a 1st in my engineering studies thanks to the help of Allah and those around me, I was awarded by the Iraqi Ministry of Higher Education a five-year scholarship for a PhD research in Magnetic Materials.

I suggested to my supervisor-to-be to build a Period Table of Elements based on magnetic properties not chemical properties but he simply was not prepared to change his group focus to my new radical idea. Instead I had to join an MSc course in Electromagnetisms at Cardiff University but Allah willed that a war starts in Kuwait in 1990 and all Iraqi assets abroad were frozen and thus my scholarship was terminated in April 1991.

I then received a sponsorship from a local Dorset Enterprise Council for an MSc course in software engineering at Bournemouth University (1994) which was followed by a PhD research study into Intelligent Data sponsored by British Telecom (1996-1999).

During my PhD study, I was invited by the European Space Agency to Brussels for my "*Valuable experiment proposal*" as they put it in their invitation letter. However I could not go as I did not hold any passport (neither Iraqi nor British) by then and Bournemouth University refused to help me in my hour of need so I left my computing studies and moved into Physics instead, self-tutoring while working as a database consultant with Racial Recorders Ltd and Versant Corporation.(UK) Ltd.

Helical Particle Waves theory was my pet subject and in May 2001 I met its founder Len Gaasenbeek, a retired Nuclear Engineer, in his summer house in Canada and after week long discussions we produced a summary and some radical implications of his theory to the fundamental nature of mass, electric charge, and magnetism [<http://www.heliwave.com/helicalwave.htm>].

After 14 years of studying and working in the UK I moved to the UAE to teach IT at the Higher Colleges of Technology and after 6 years, I moved to China and with Allah's permission have spent the last six months researching the relationship between prime numbers and the Quran which resulted in this humble work which I sincerely hope it will add new knowledge to the Islamic library and not simply another noise.

Poems by Author

My Dream Lady

Ali Adams 2002-09-03

*sweet and innocent that is you
love forever I'd give you
let me be your faithful guide
through this thorny short-life ride
low and high we fly together
trials we face, in love they wither
and when we're near the end
no one but God for help we send*

Sleepless Lake

Ali Adams 2005-02-09



*every night I long to you
all dreams I share with you
unlike sheeple my sleepless lake
you're always here for me awake
embrace our secret, deep under the waves
like our watery moon, silently rays
high and low we share the pleasure
building together a universal treasure
Judgment Day may soon be now
and longing souls to the Truth will bow
guiding spirits will then say bye
and sorry souls will beg The High*



Directorate of Manned Spaceflight and Microgravity

SUCCESS

(Space Station Utilisation Contest Calling for European Students Initiatives)

TEAM-DAY

12th May 1999, ESTEC, Noordwijk, The Netherlands

Ali Adams

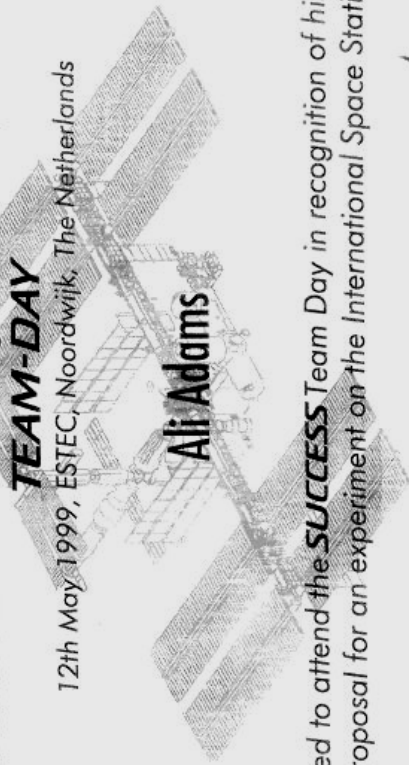

was invited to attend the **SUCCESS** Team Day in recognition of his valuable proposal for an experiment on the International Space Station

Dr. Karl Knott

Head of the Microgravity and Space Station Utilisation Department

Dr. Ulf Merbold

ESA Astronaut

European Space Agency Invitation, 1999

The Sheeple

*False has become true...and chaos has spread
Liars are upheld...and good mouths are well weld
Wisdom deserted all...but a sleepless few
Trance became the norm...and to reality blindness wed
No freethinking was left...so long as they were fed
Sleep sheep most became...buried in a borrowed bed
Wake up and uphold...what God has always said:
Don't step over others...to reach a higher end
Love each other so...to the Truth you'd be led.*

Ali Adams

*Please consider giving to people, animals, and plants near you
love, clean air, water, food, medicine, clothes, etc. and send
sincere greetings to our beloved Prophet Muhammed and his
progeny may Allah's blessings be upon them all.*

Allah is the only Giver and all rewards go in circles of π .